

ETH

Eidgenössische Technische Hochschule Zürich
Swiss Federal Institute of Technology Zurich

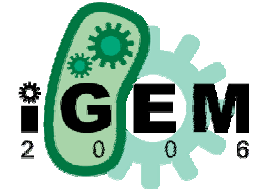

Half Adder - Modeling Overview

August 28, 2006



System Architecture

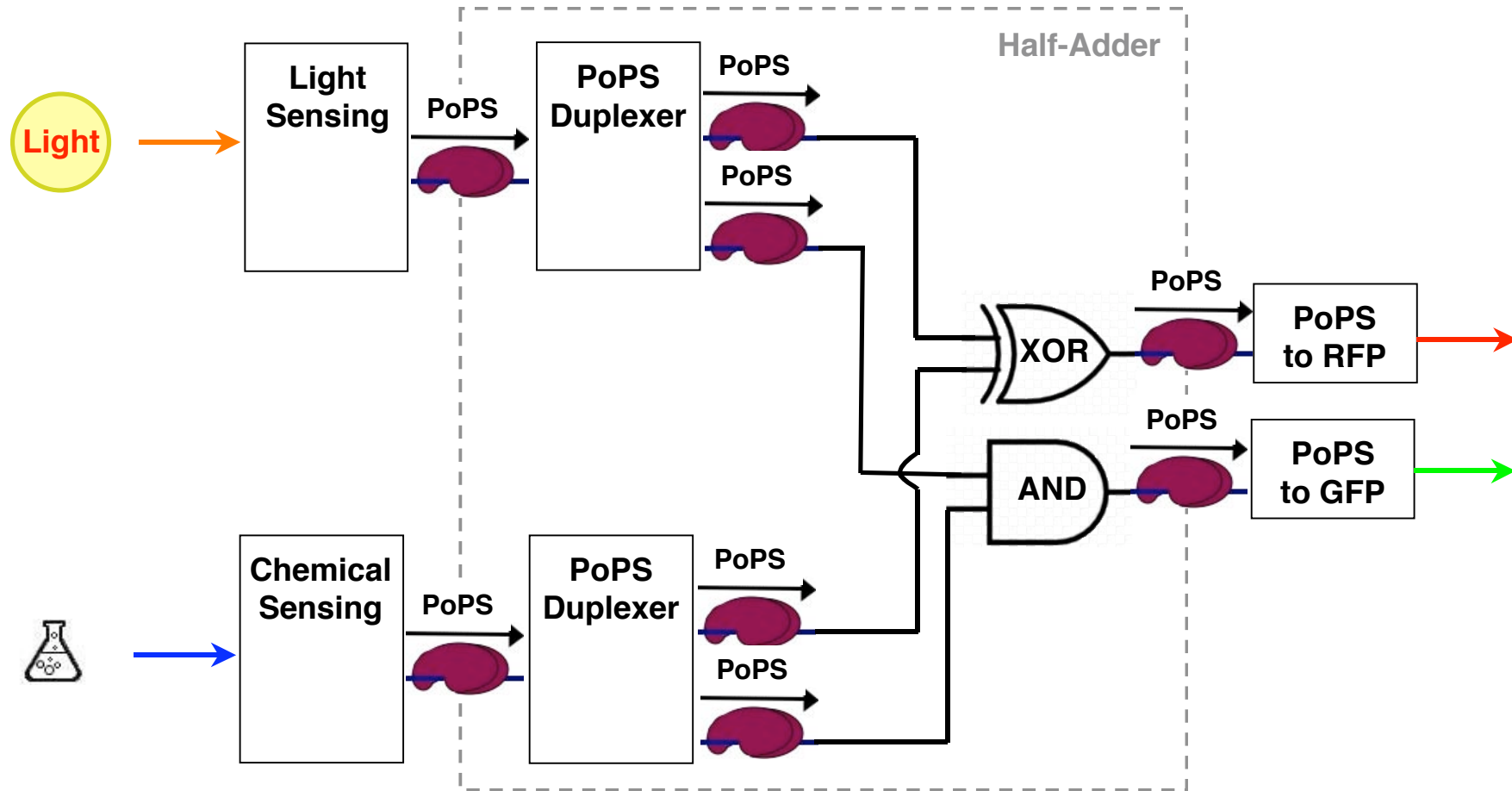

Light Sensing

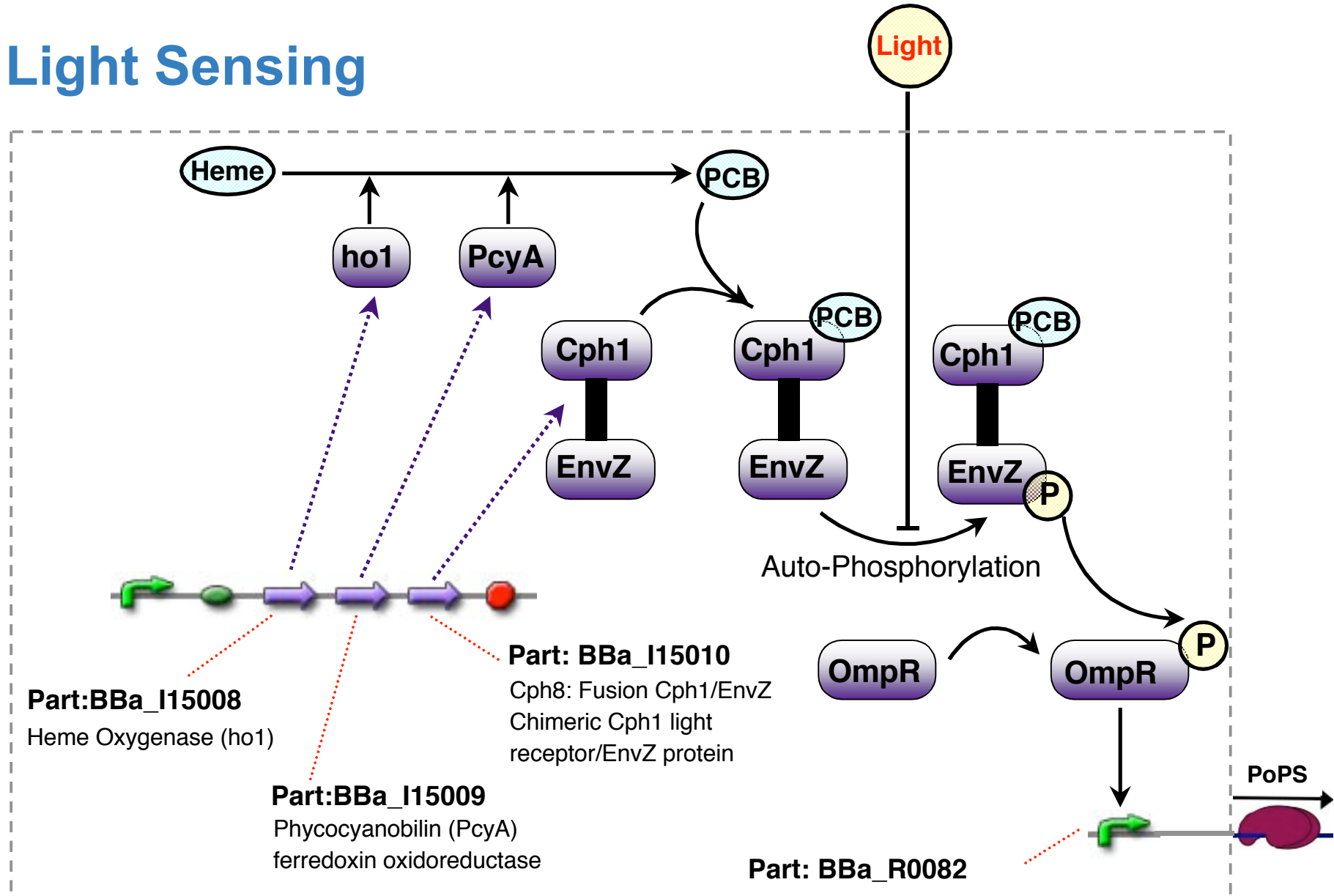

Chemical Sensing

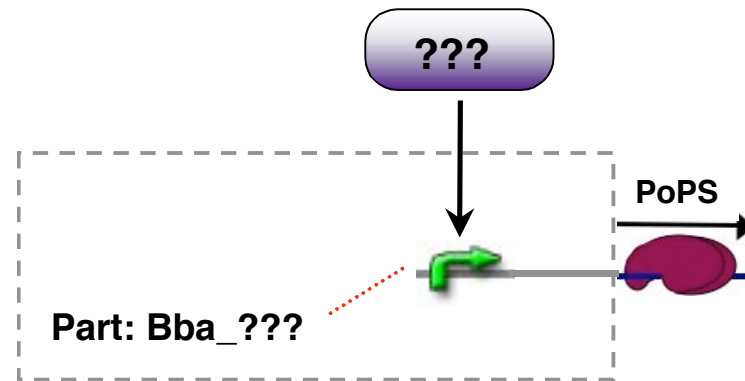

PoPS Duplexer

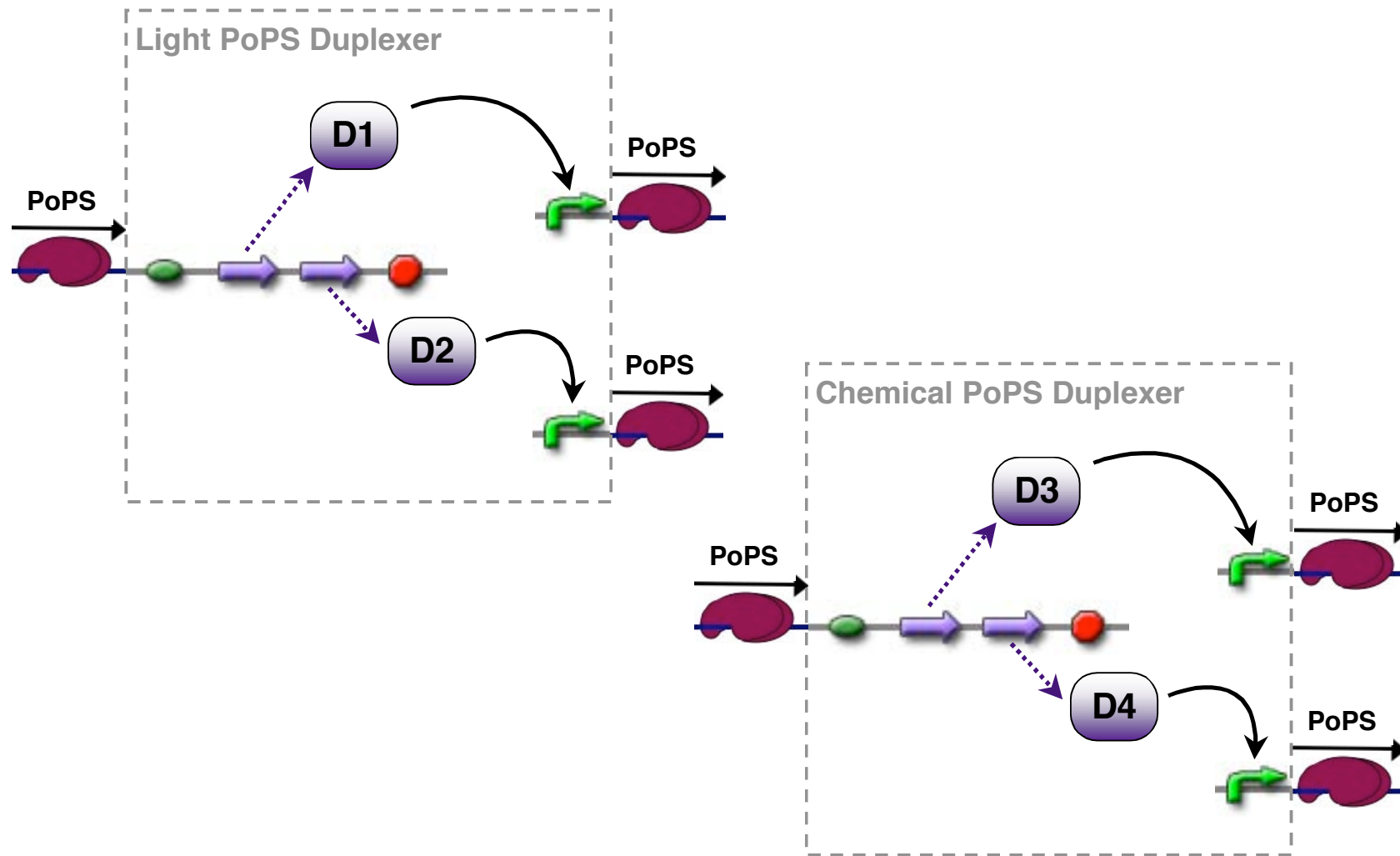

AND (Version A)

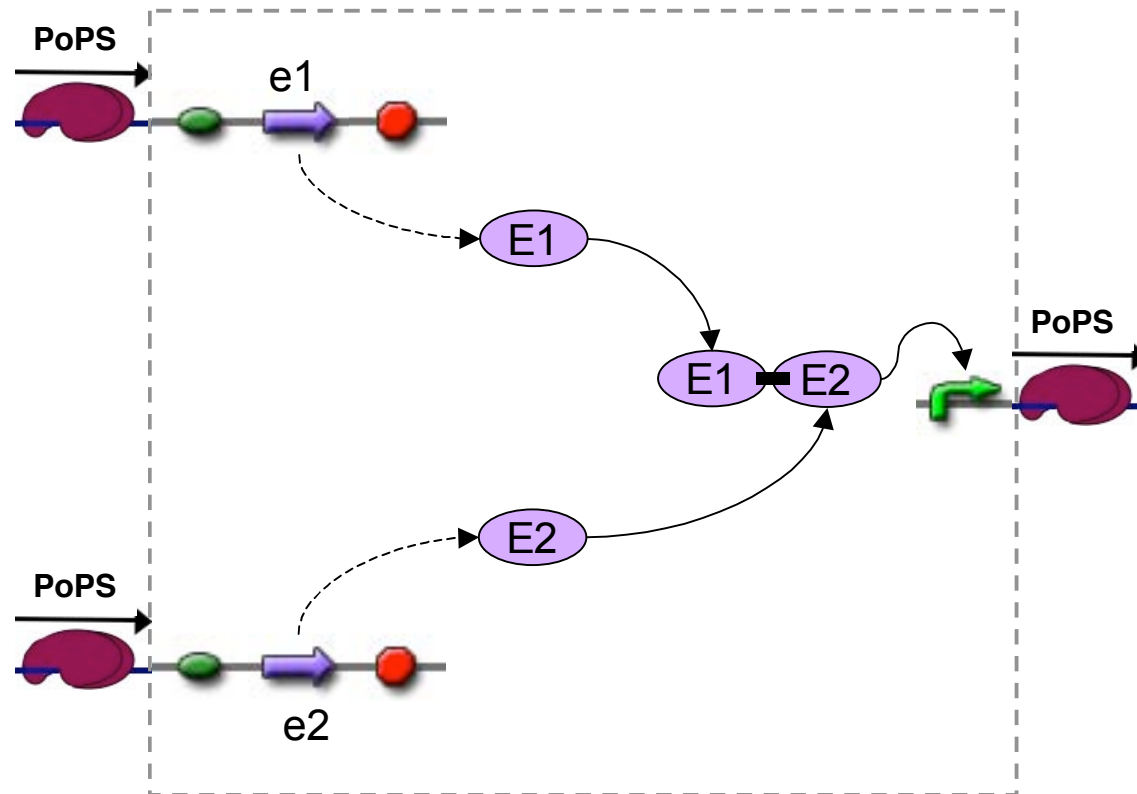

AND (Version B)

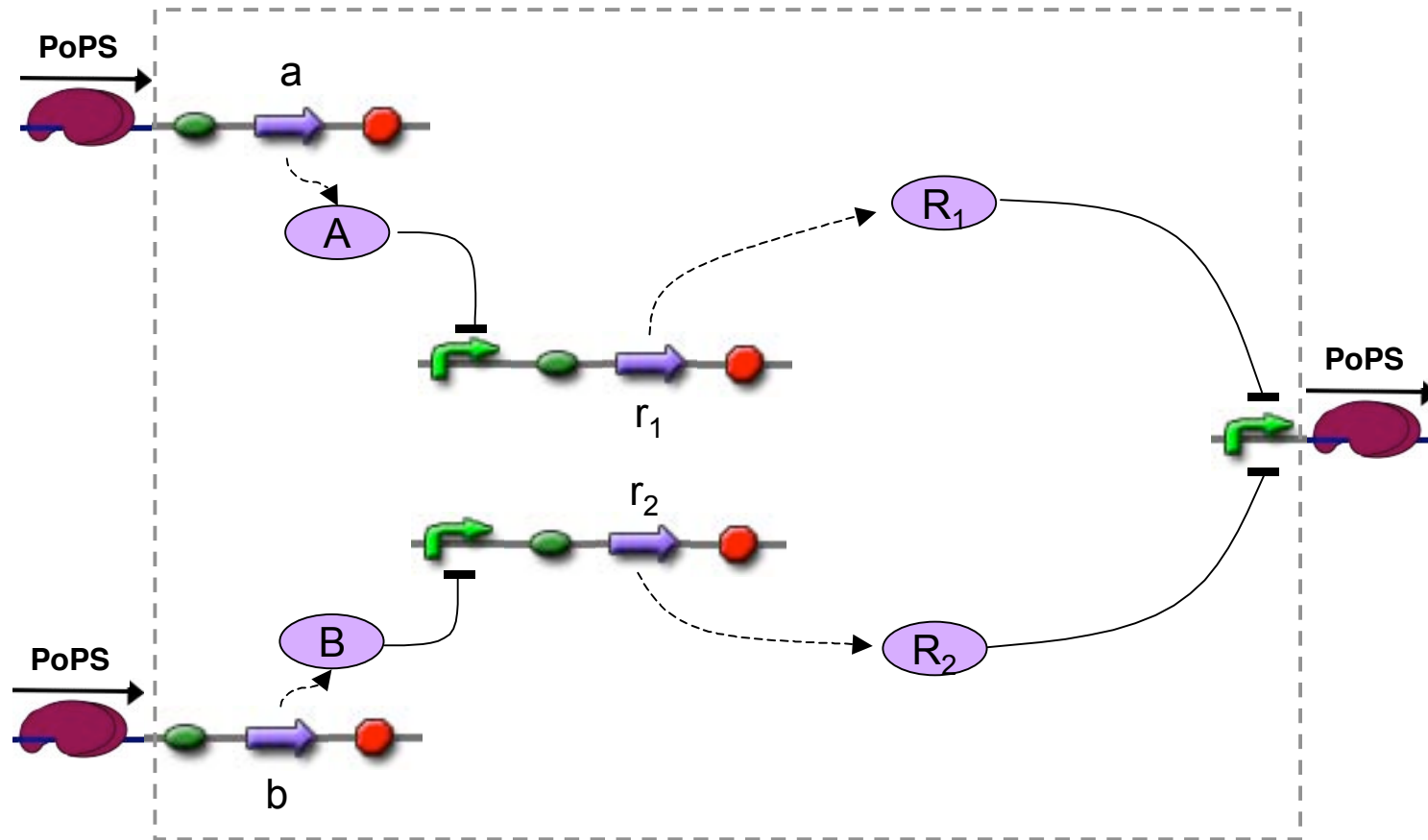

XOR

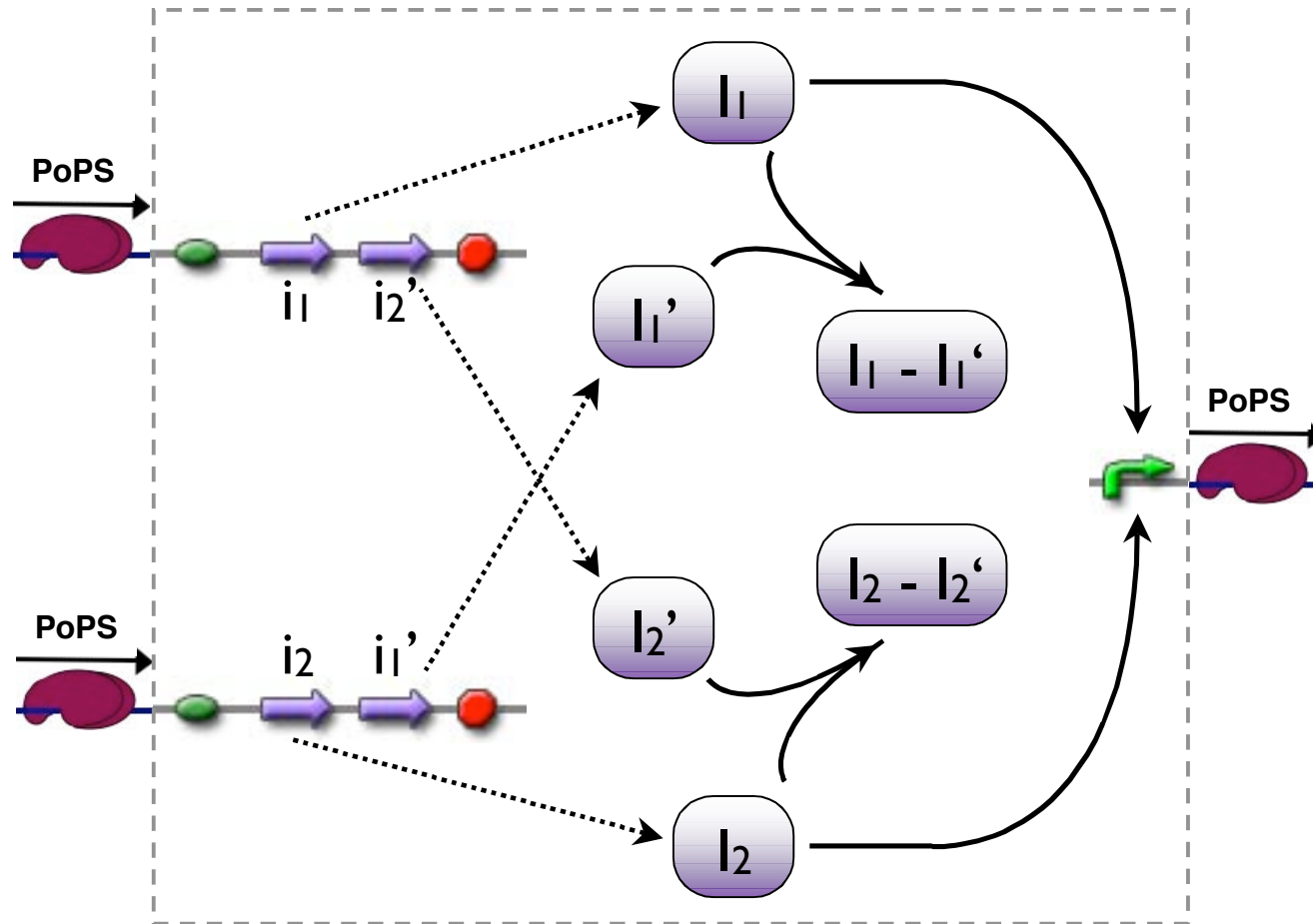

PoPS to Reporter

