

Brown iGEM

Genetically Engineered Machine Competition 2006



Who are we?

- 9 undergraduates advised by
 - 4 graduate students
 - 20 faculty from diverse departments
- 3 biologists, 2 engineers, 2 computer scientists,
- 1 physicist, and 1 biochemist.
- Synthetic Biology Journal club

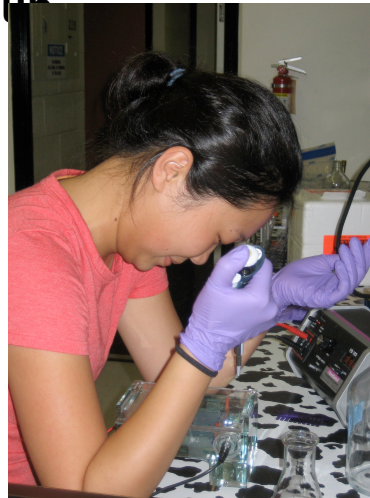

Bacterial Freeze Tag

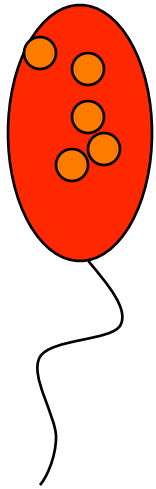

"IT" Cell

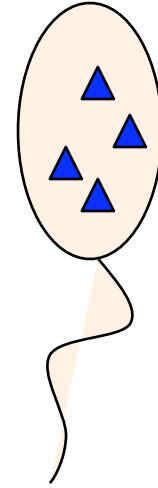
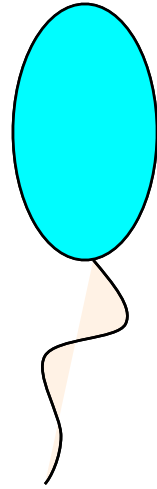

Unfreezer

Bacterial Freeze Tag

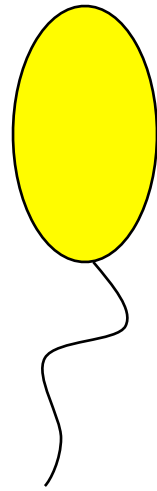
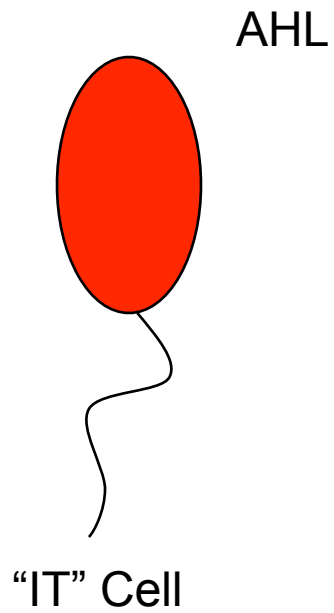

AI-1

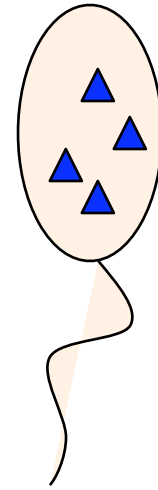

Sender ("IT") Cell

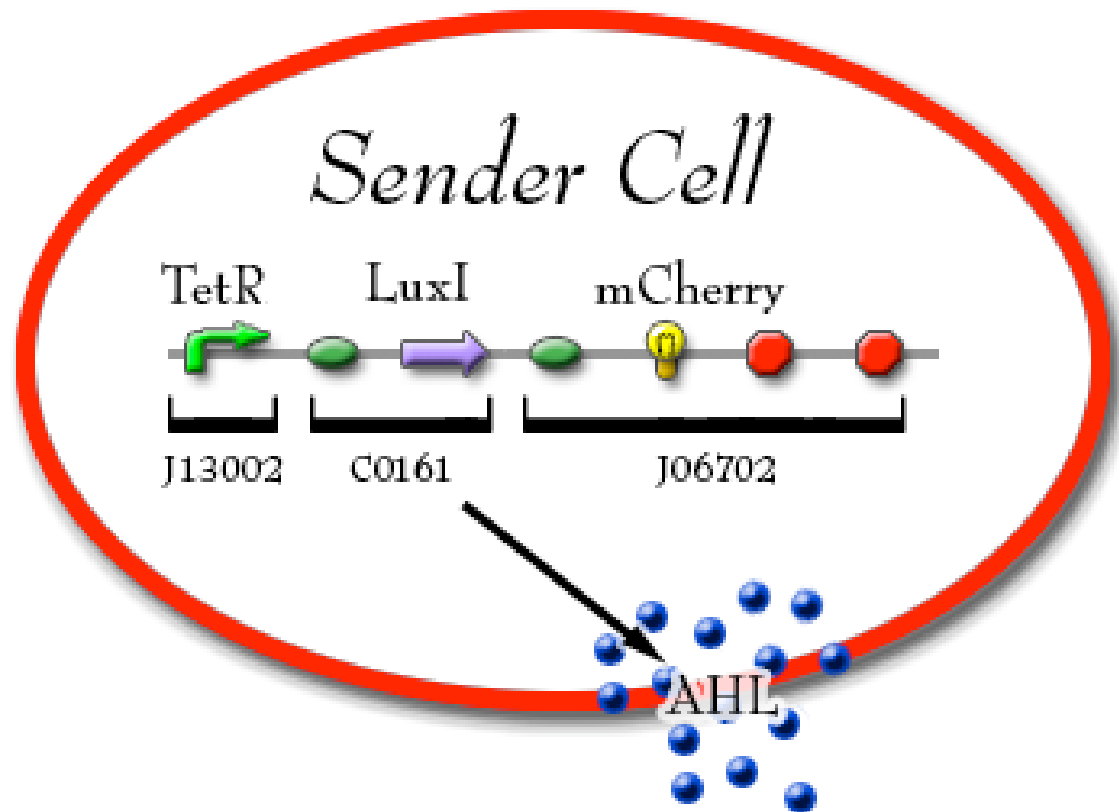

AHL Receiver

MotB Knock Out

Dr. Unfreezer

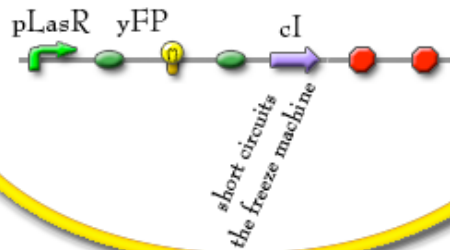

AHL Receiver

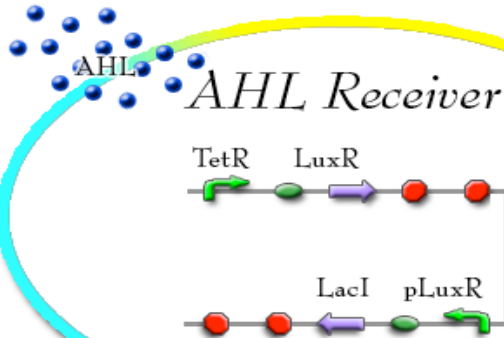

Freeze Machine

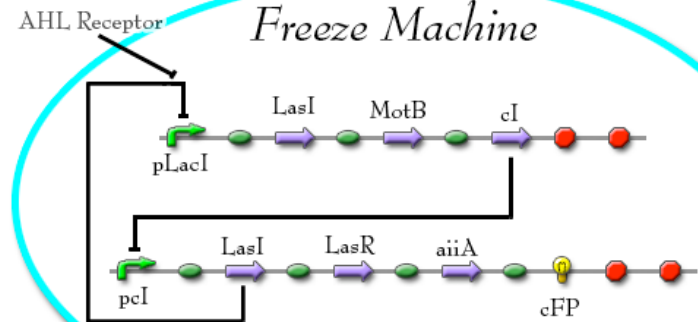

AHL Receiver

MotB Knock Out

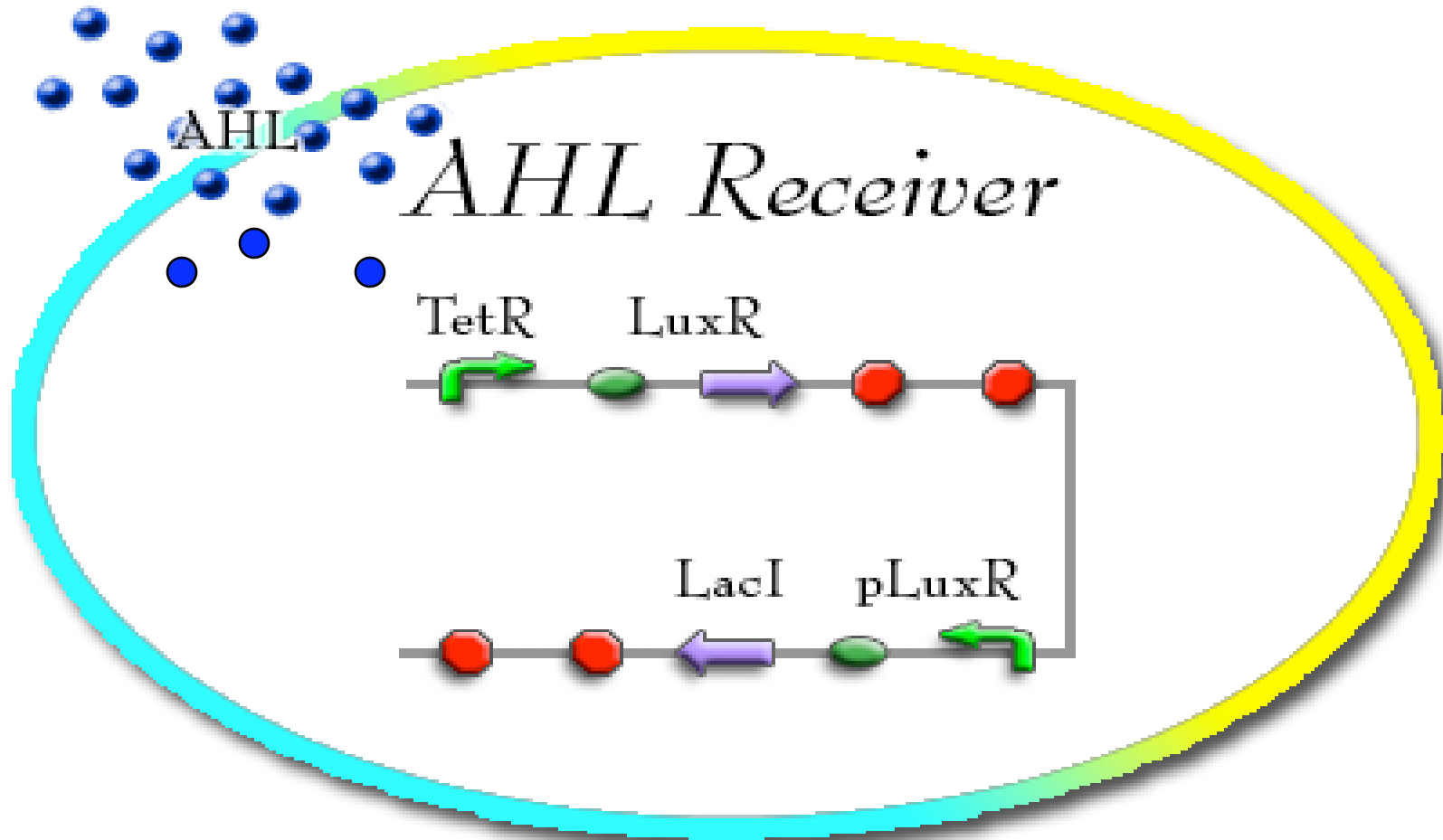

AHL Receiver

MotB Knock Out

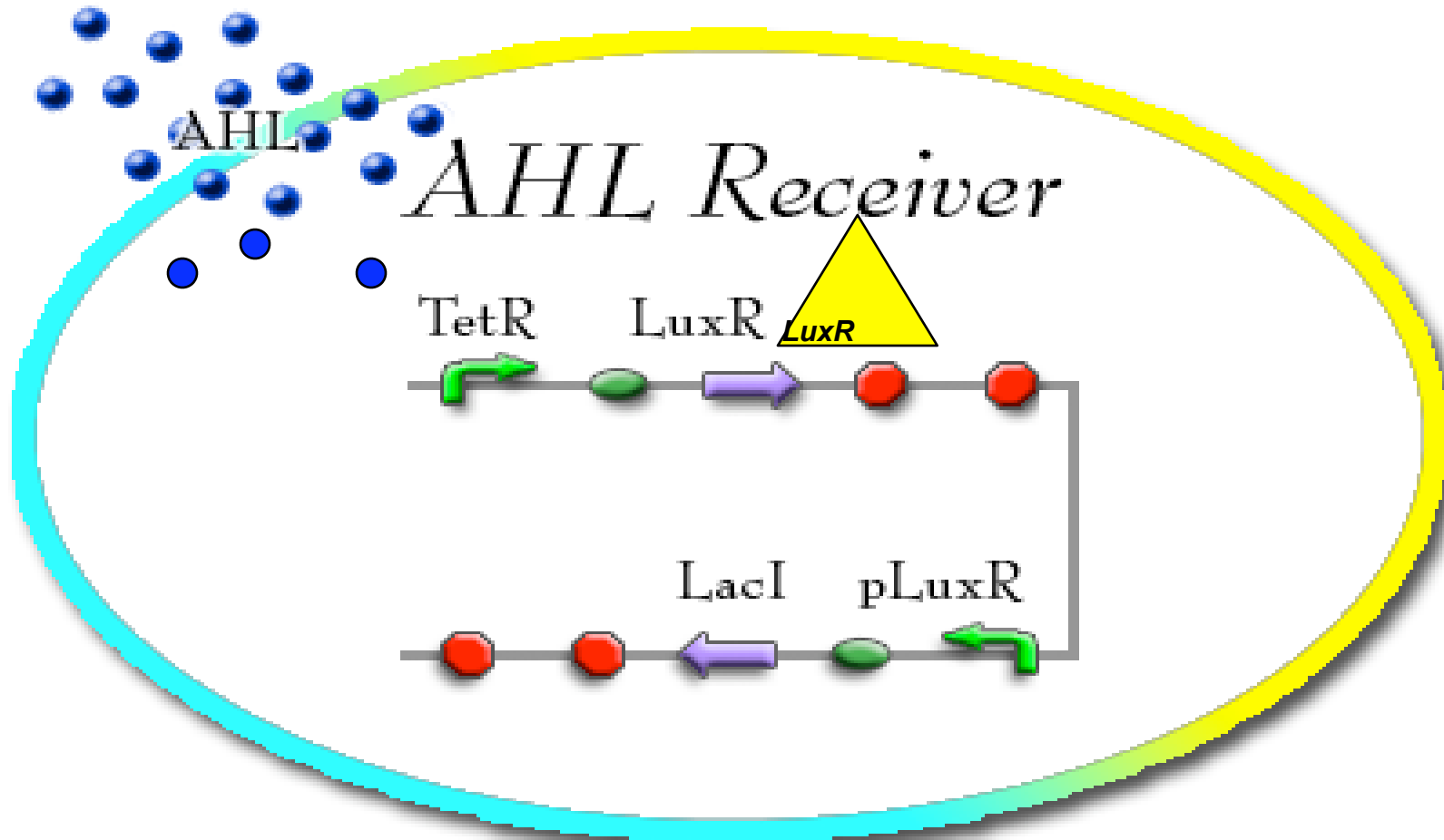

AHL Receiver

MotB Knock Out

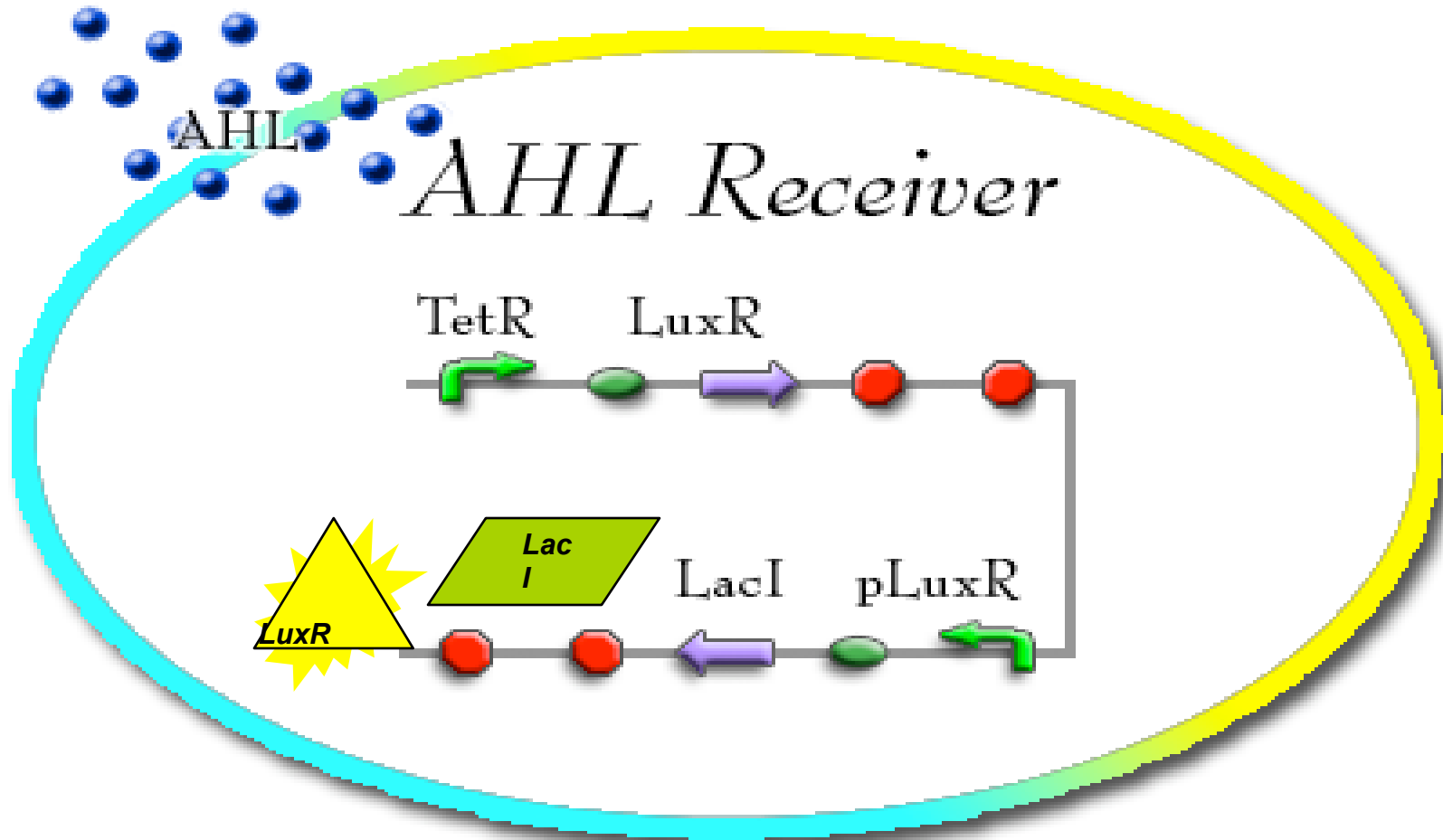

Freeze Machine: Freezing

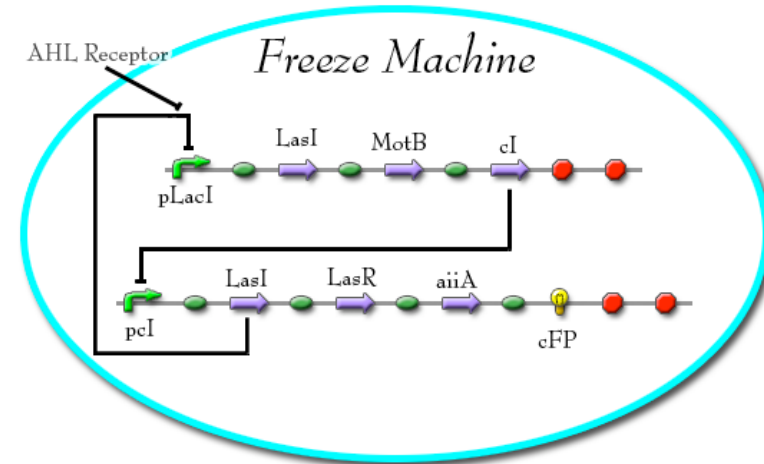
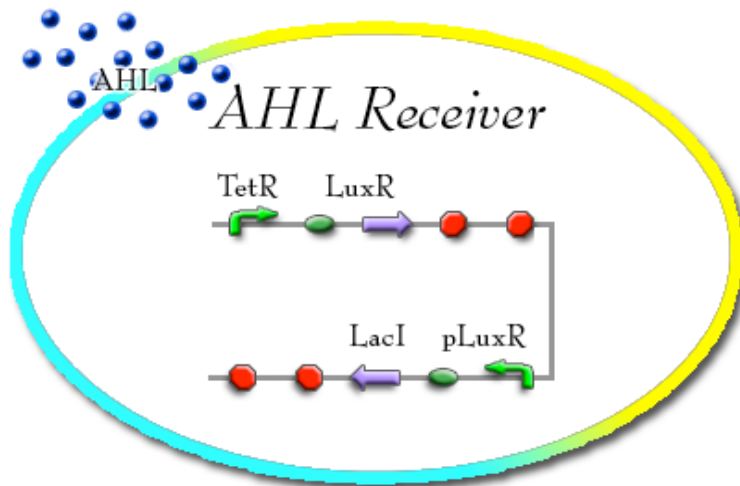
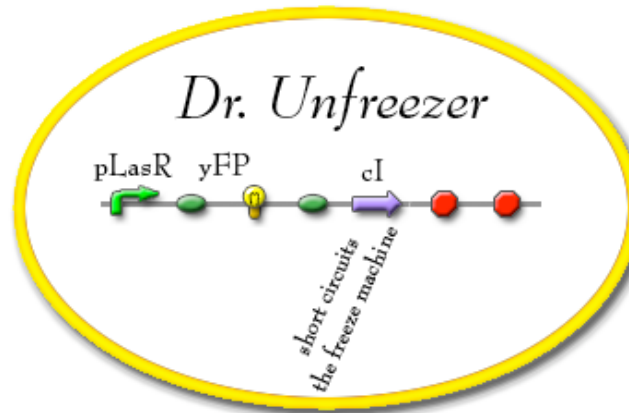
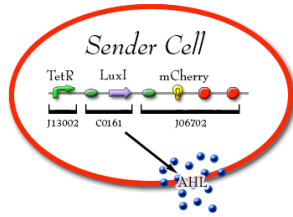

Freeze Machine: Freezing

Freeze Machine

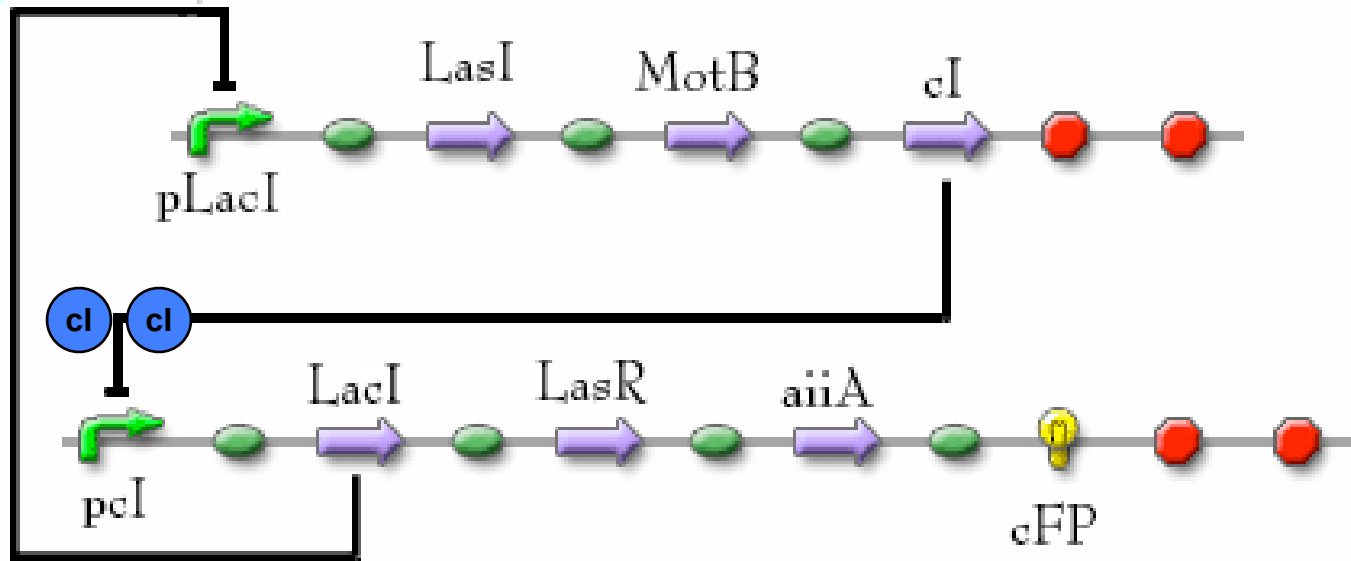

Freeze Machine: Freezing

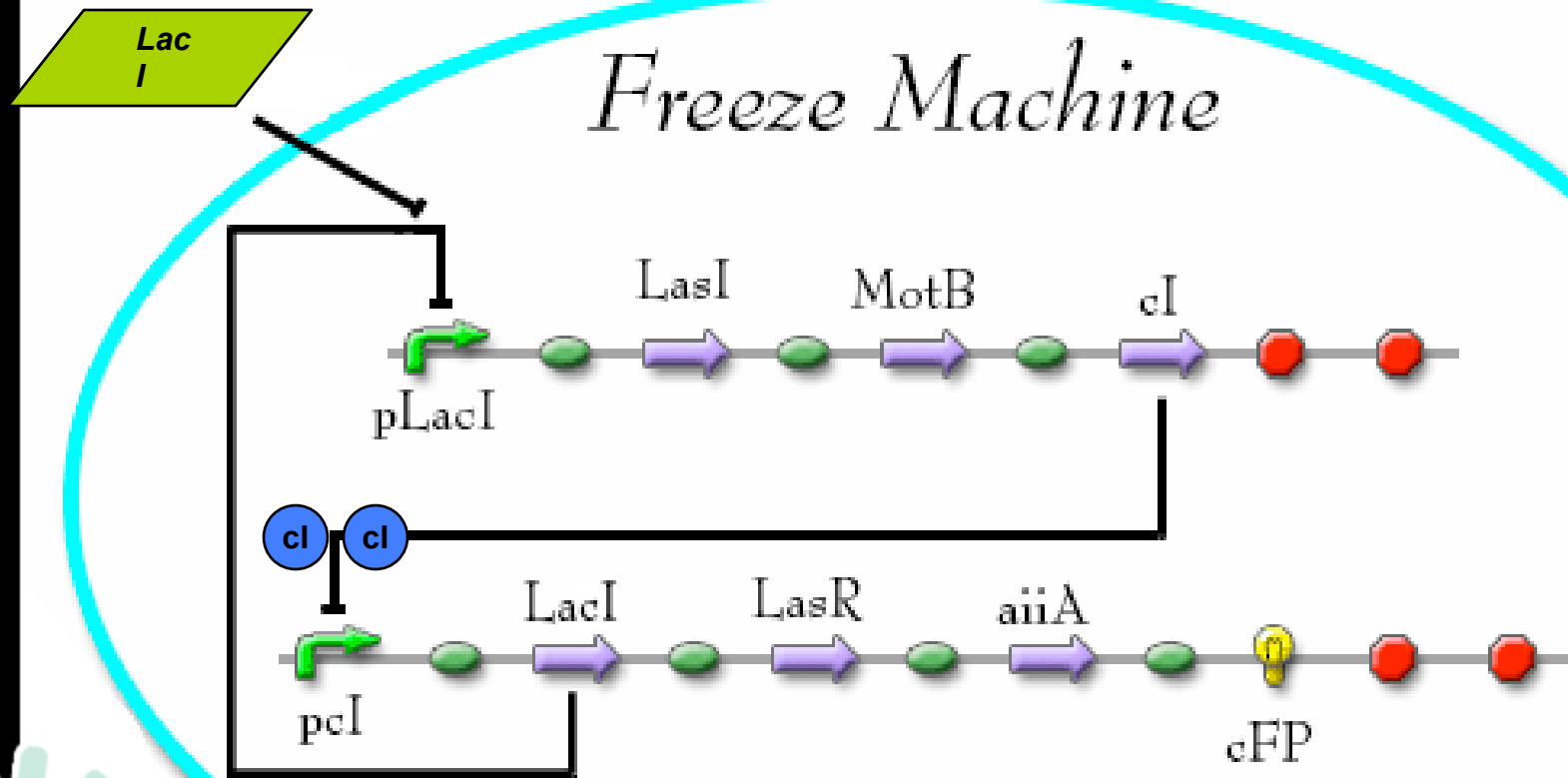

Freeze Machine: Freezing

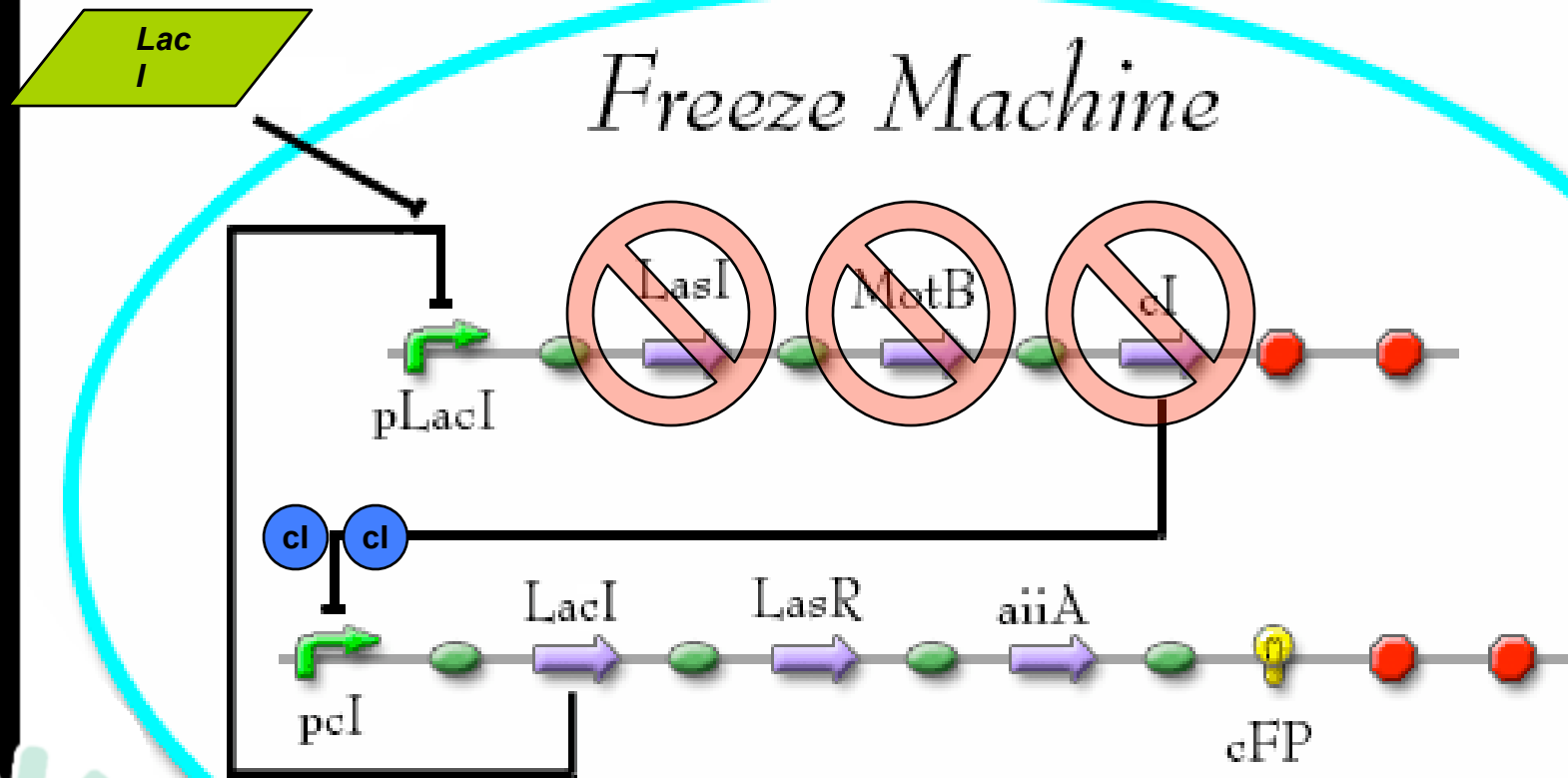

Freeze Machine: Freezing

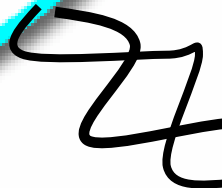
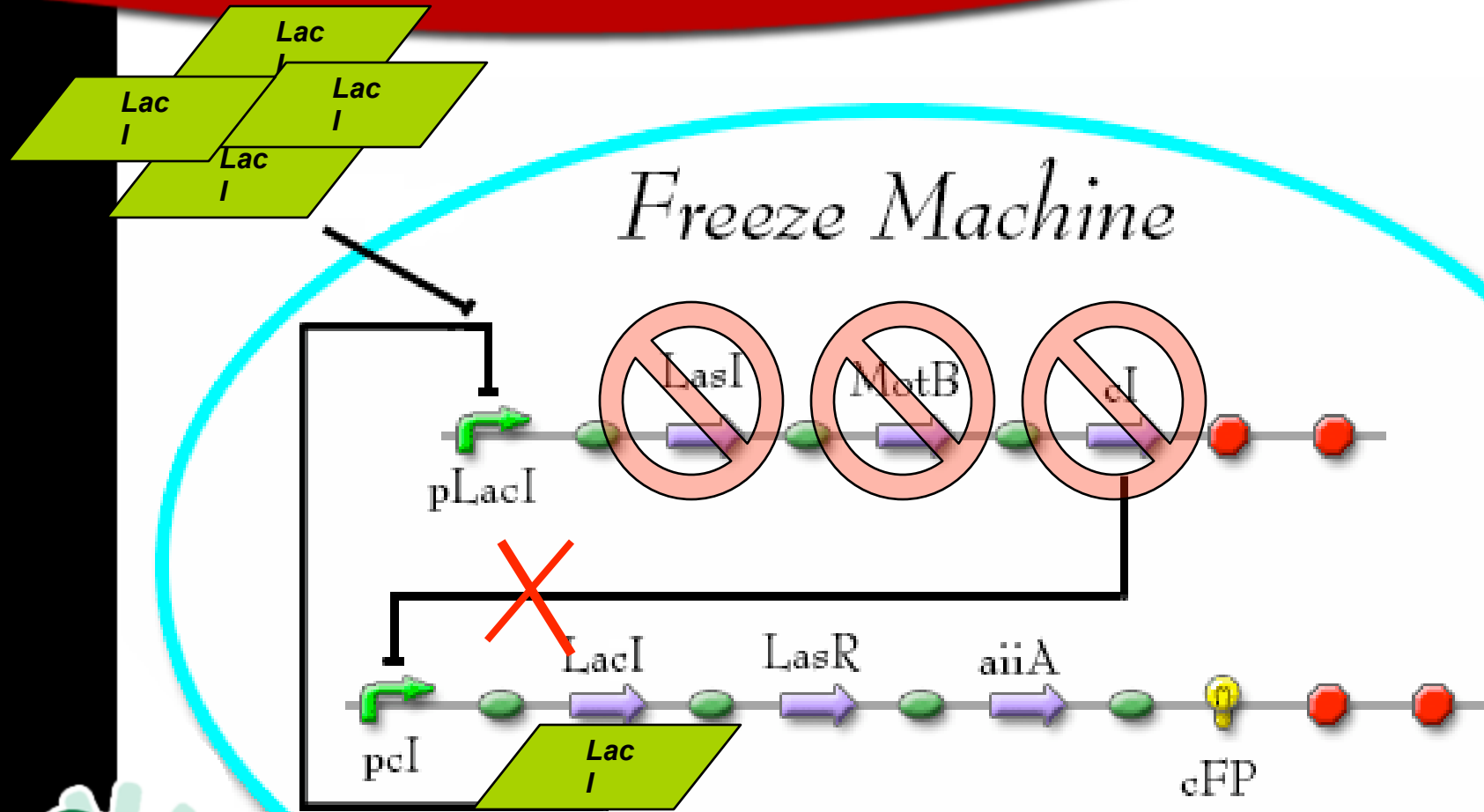

Freeze Machine: Freezing

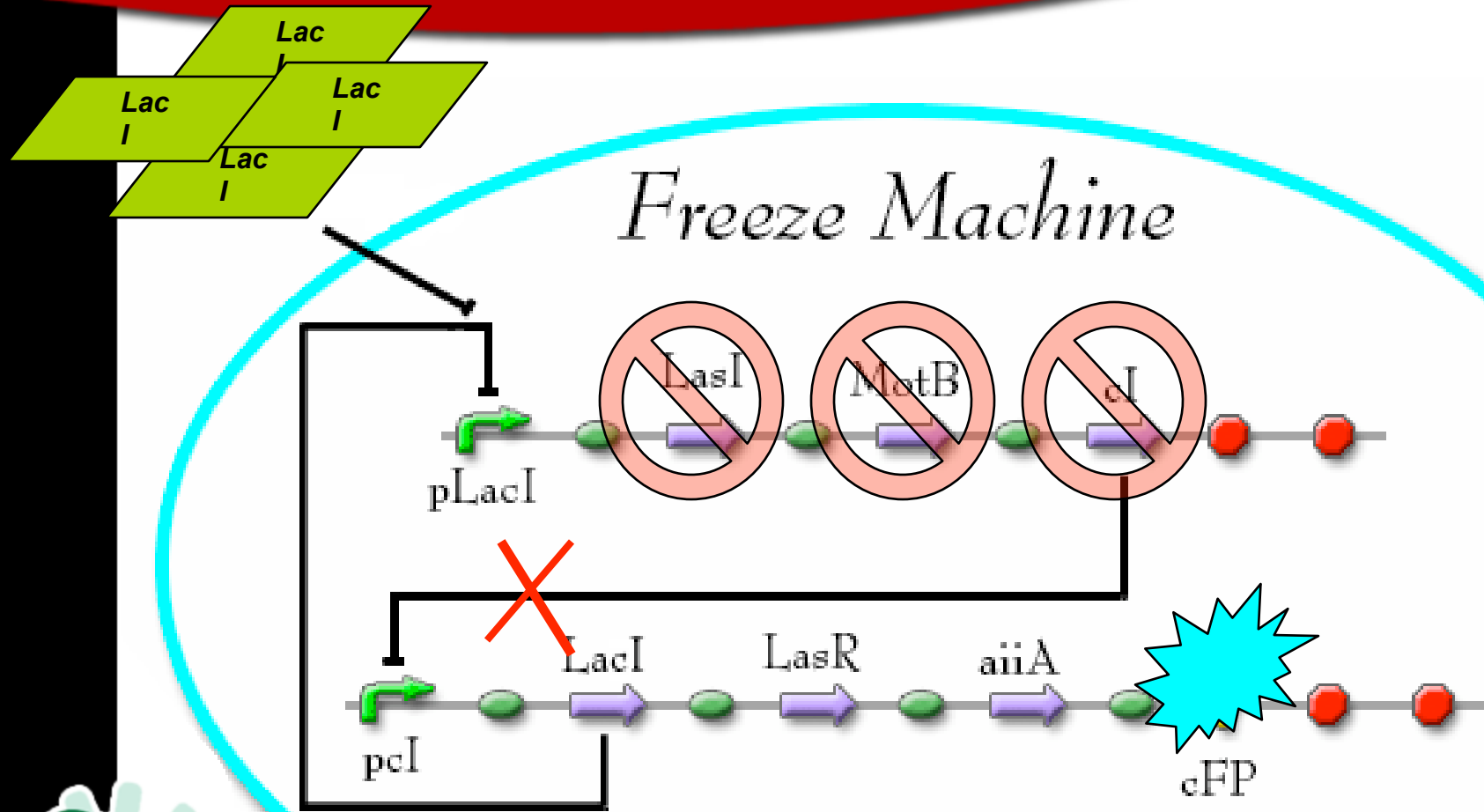

Freeze Machine: Unfreezing

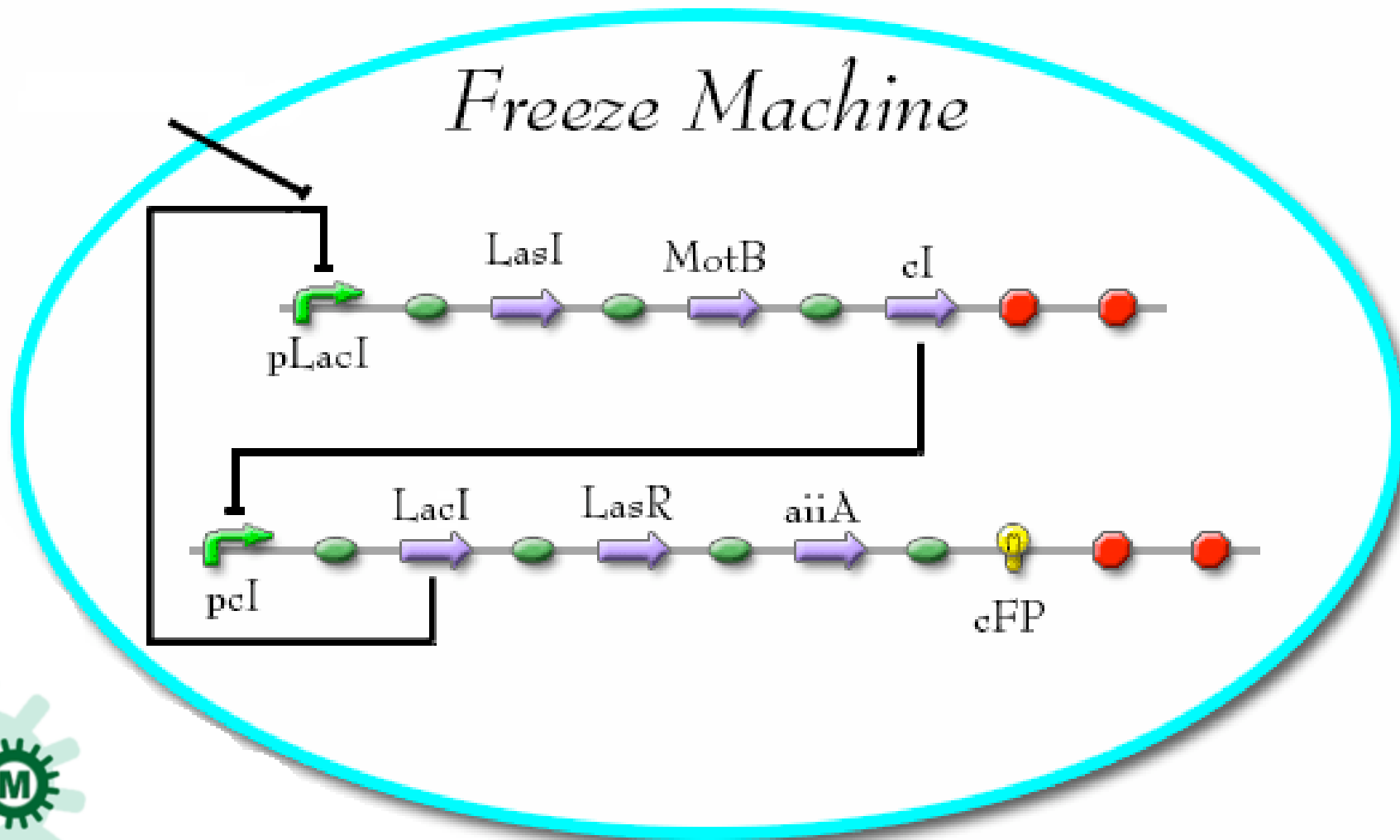

Freeze Machine: Unfreezing

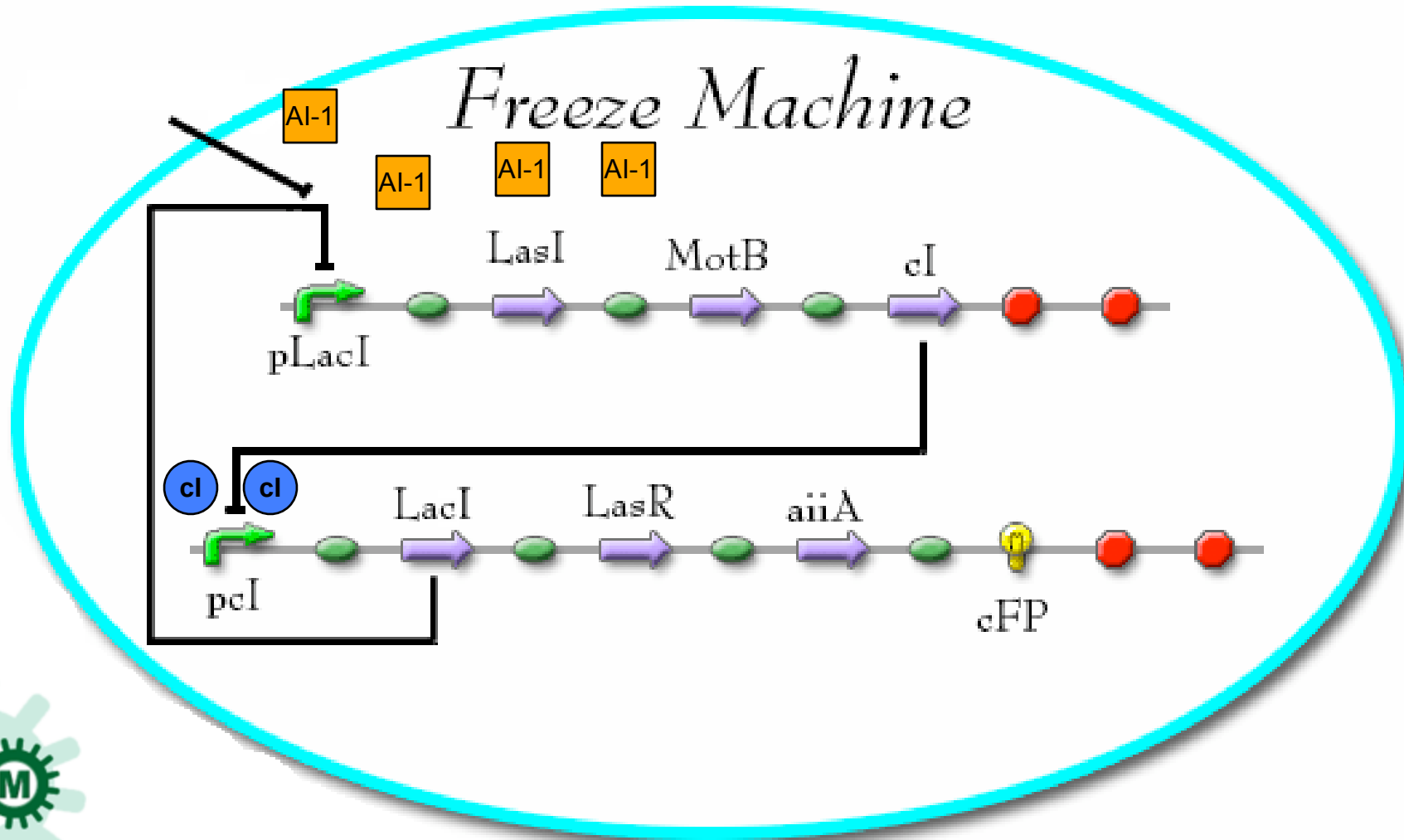

Freeze Machine: Unfreezing

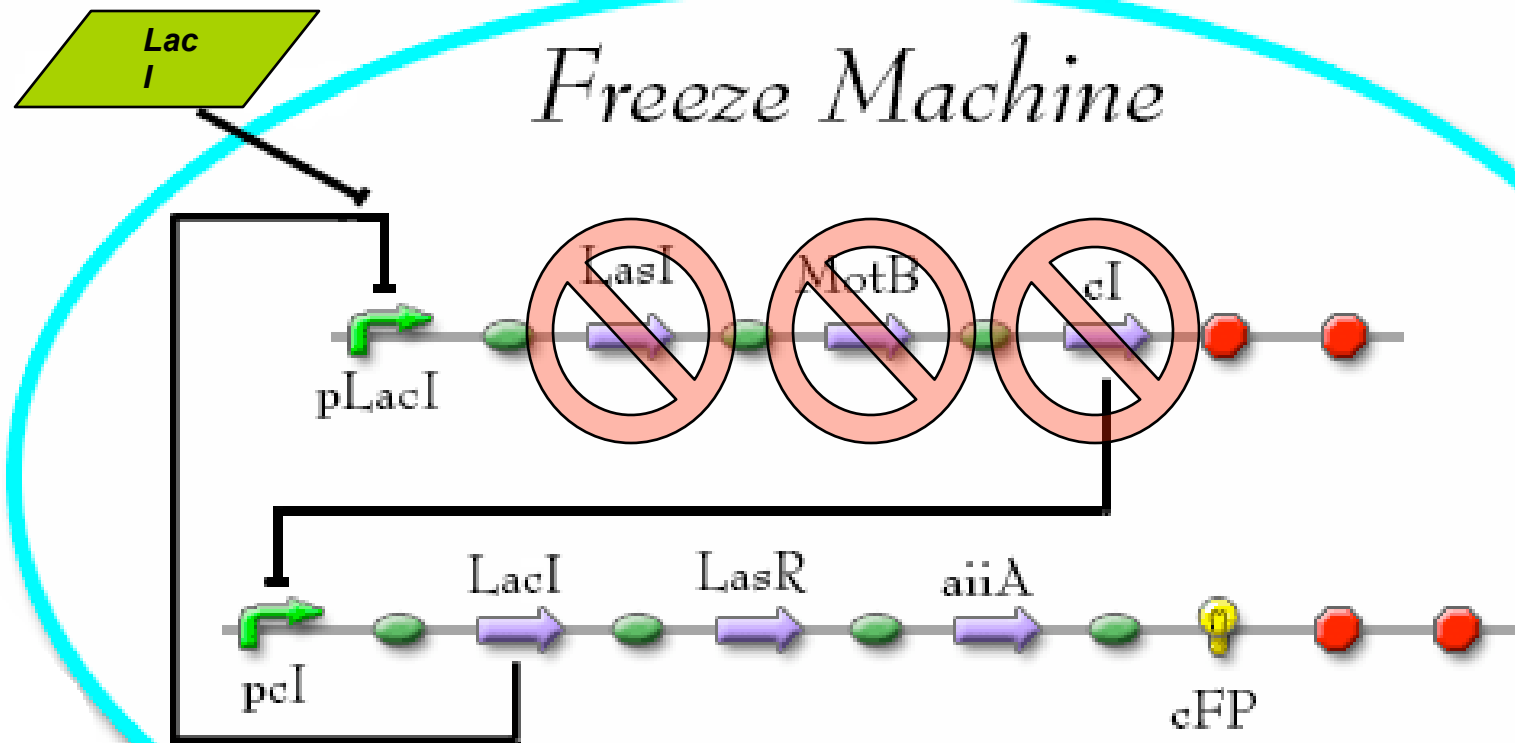

Freeze Machine: Unfreezing

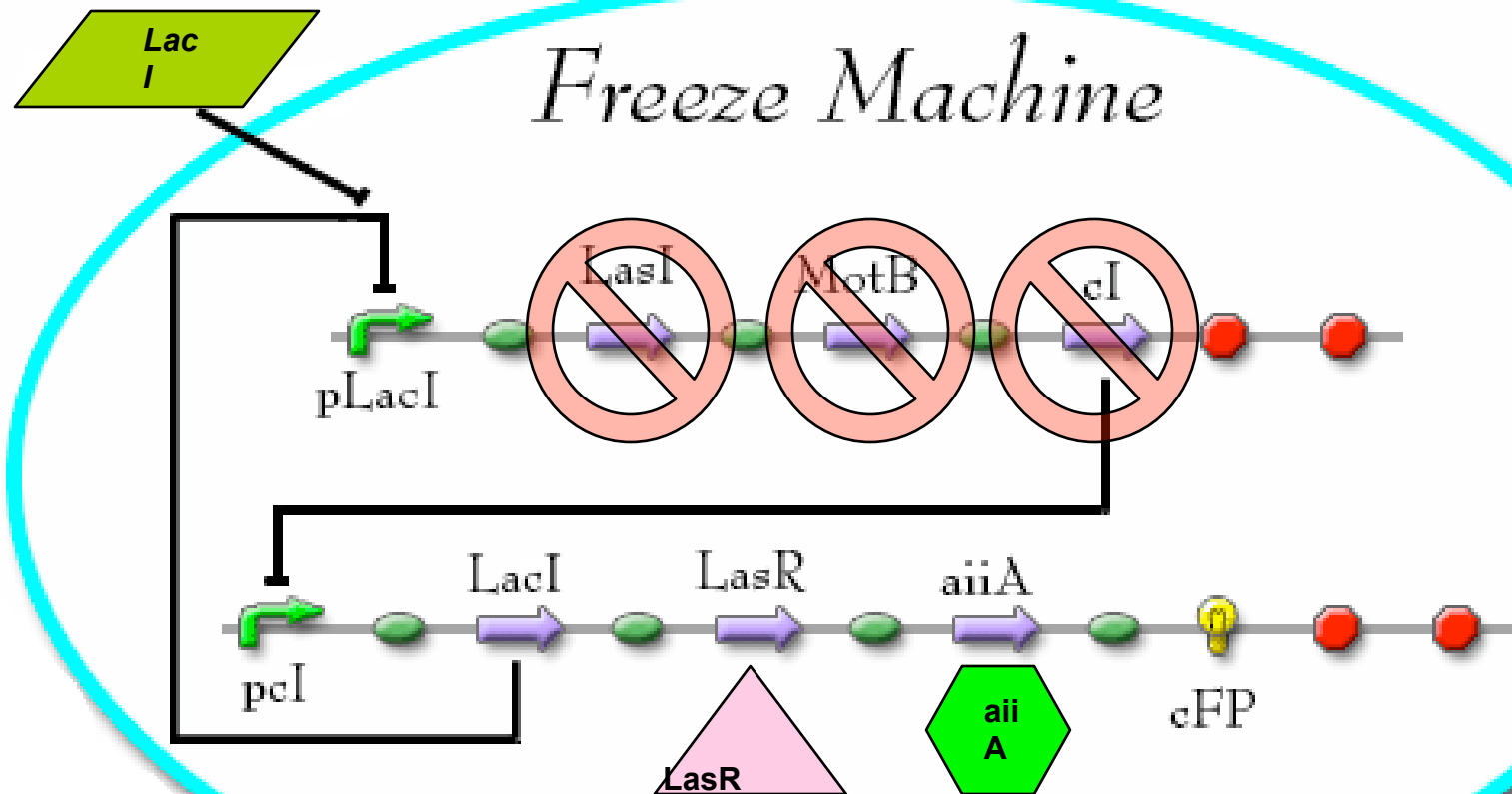

Dr. Unfreeze

Dr. Unfreezer

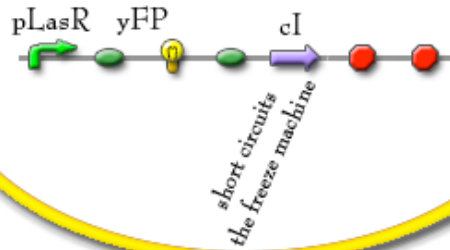

AHL Receiver

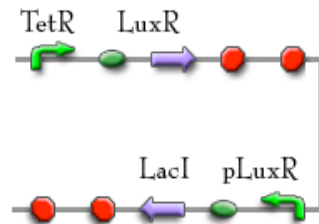

AHL Receptor

Freeze Machine

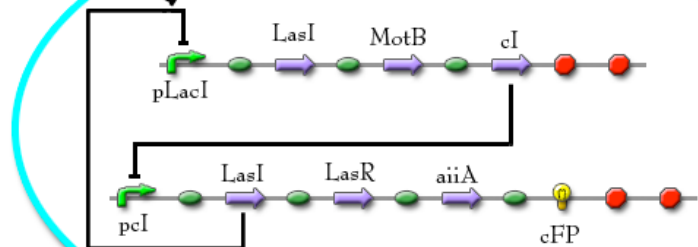

Dr. Unfreeze

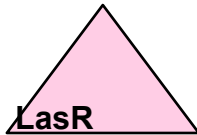

Dr. Unfreezer



*short circuits
the freeze machine*



Dr. Unfreeze

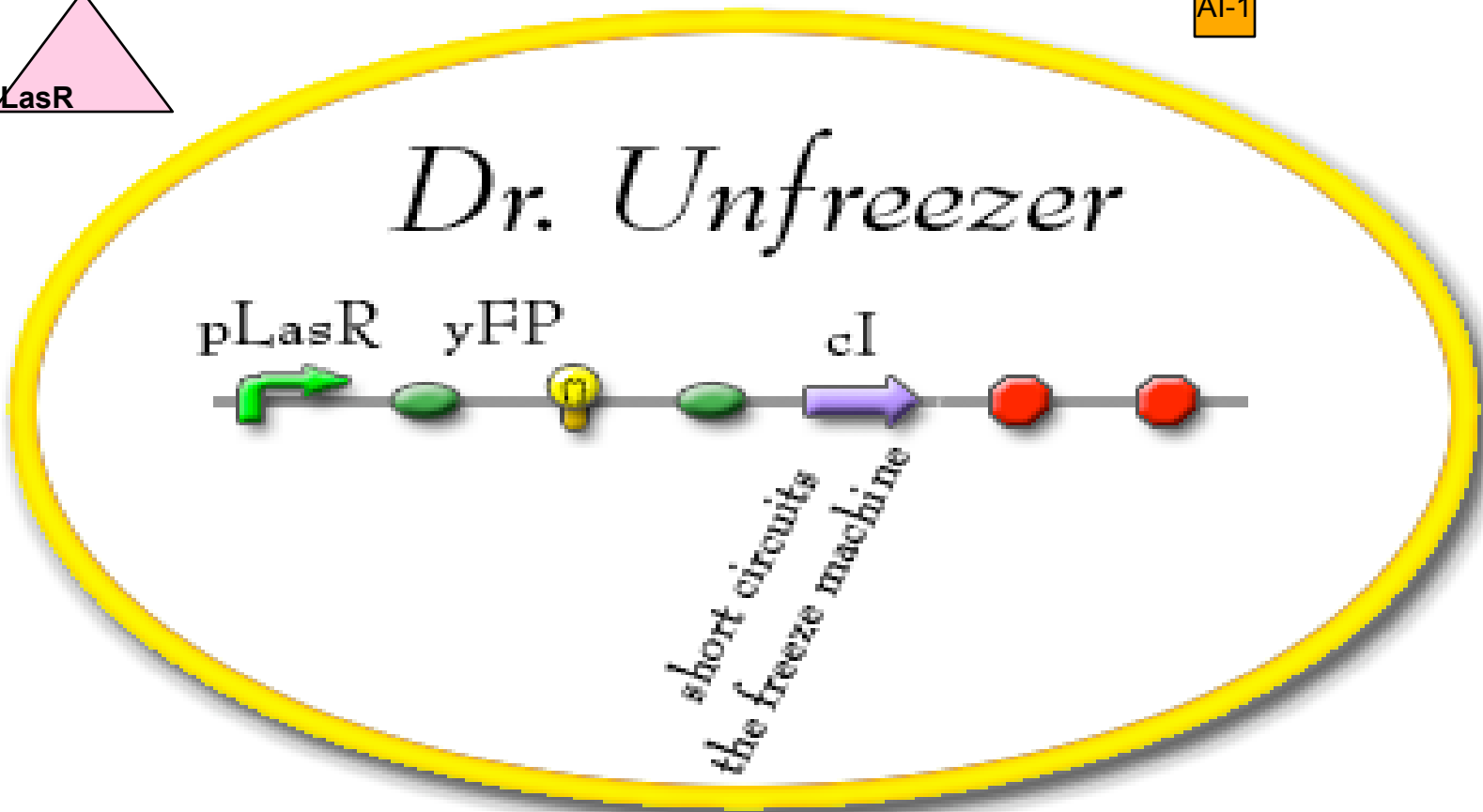
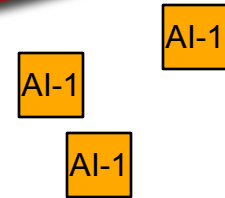
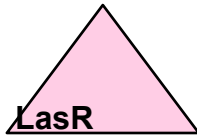

Dr. Unfreeze

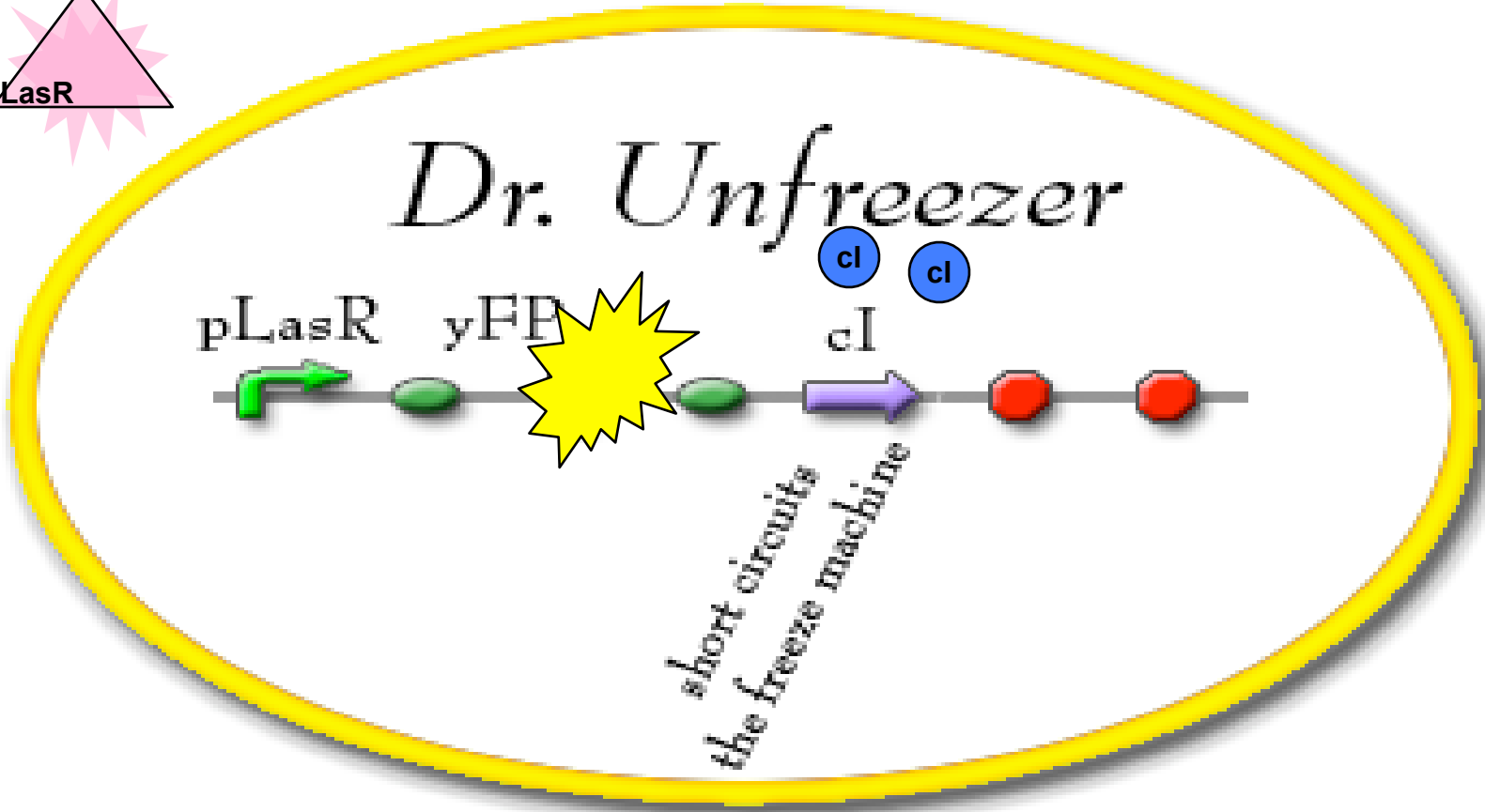
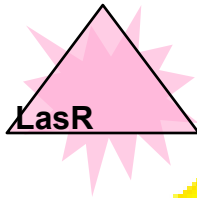

Freeze Machine: Unfreezing

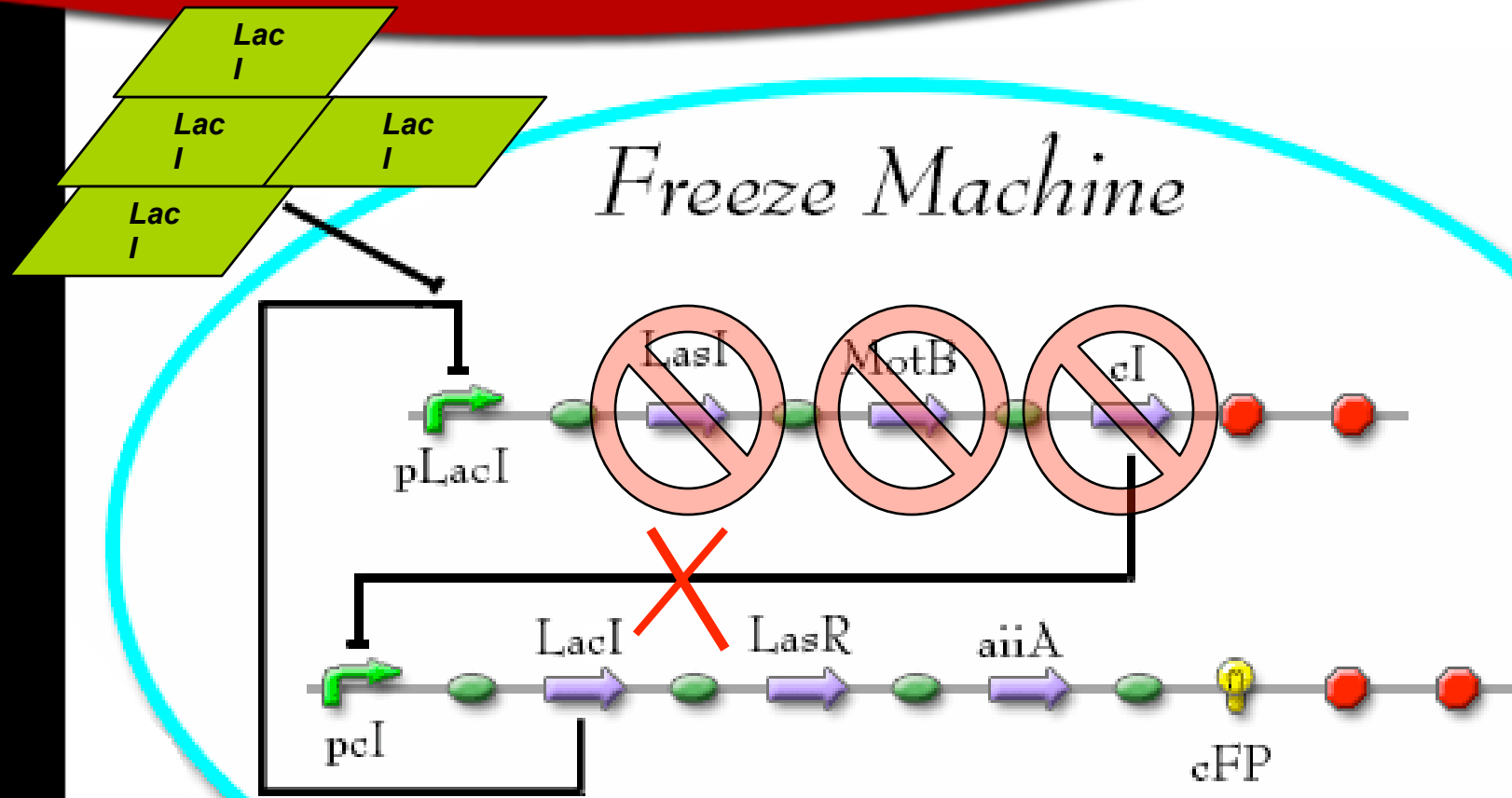

Freeze Machine: Unfreezing

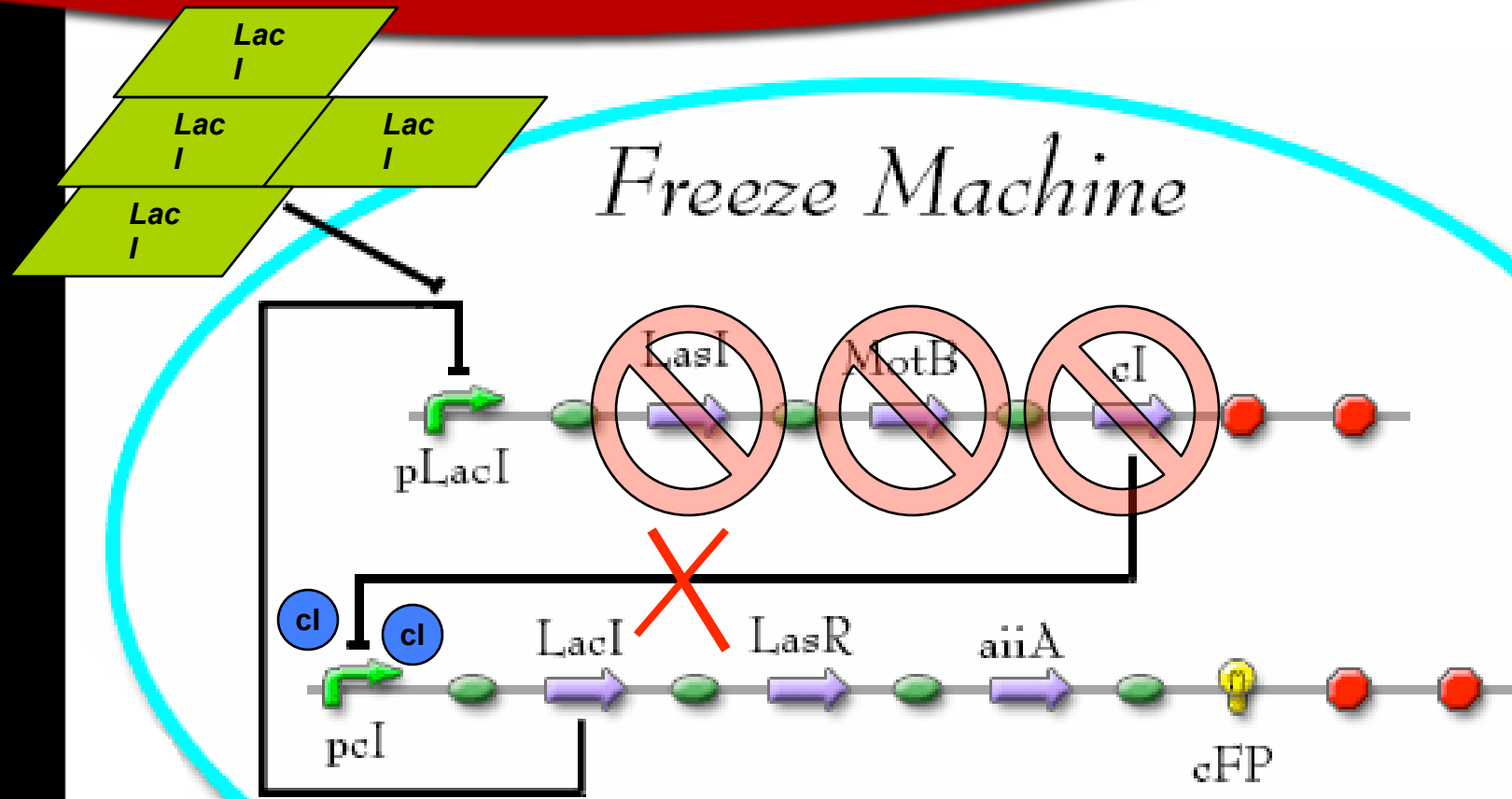

Freeze Machine: Unfreezing

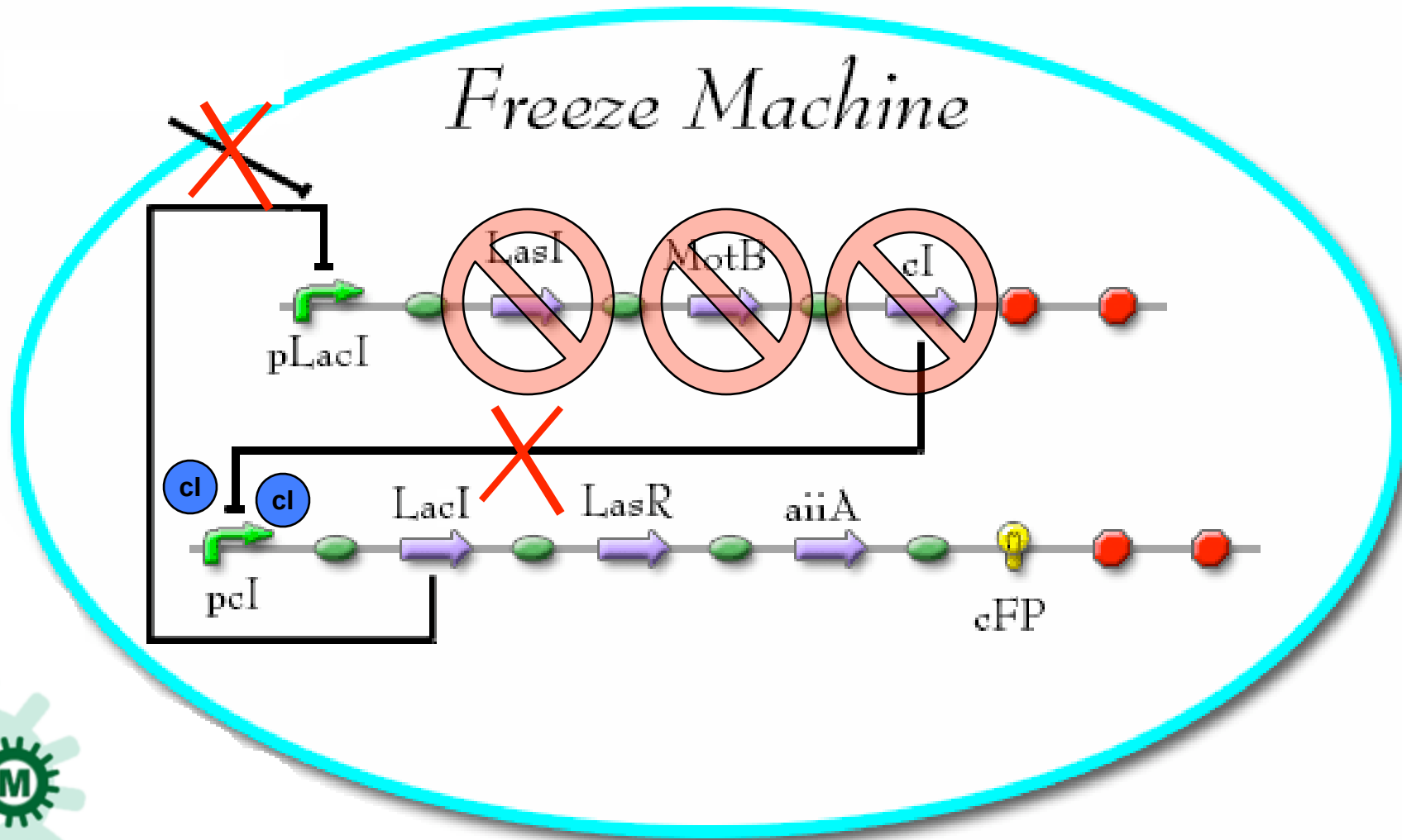

Freeze Machine: Unfreezing

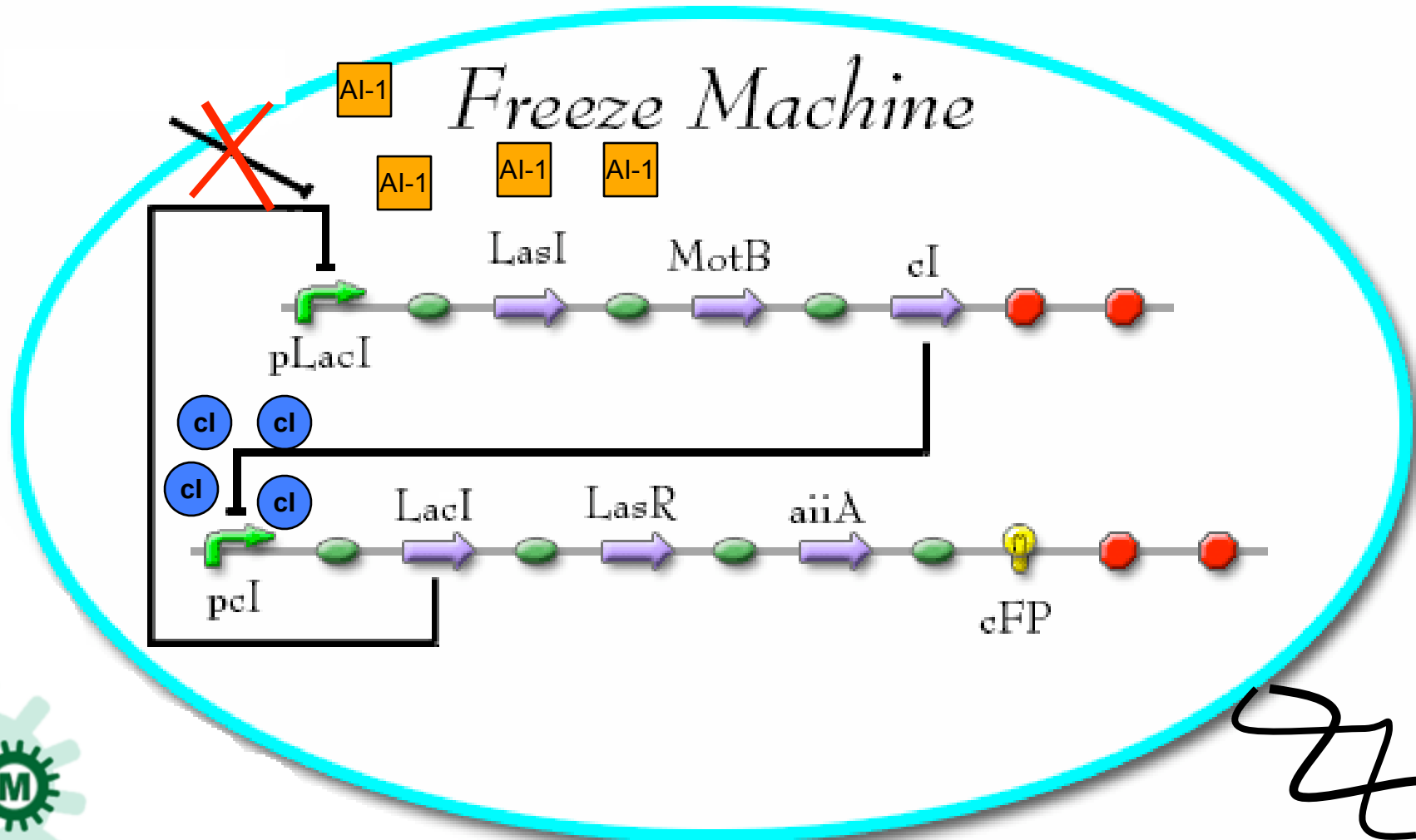

The Tri-stable Toggle Switch



The Tri-stable Toggle Switch

Construction of a genetic toggle switch in *Escherichia coli*

Timothy S. Gardner^{*†}, Charles R. Cantor^{*} & James J. Collins^{*†}

** Department of Biomedical Engineering, † Center for BioDynamics and ‡ Center for Advanced Biotechnology, Boston University, 44 Cummington Street, Boston, Massachusetts 02215, USA*



The Tri-stable Toggle Switch

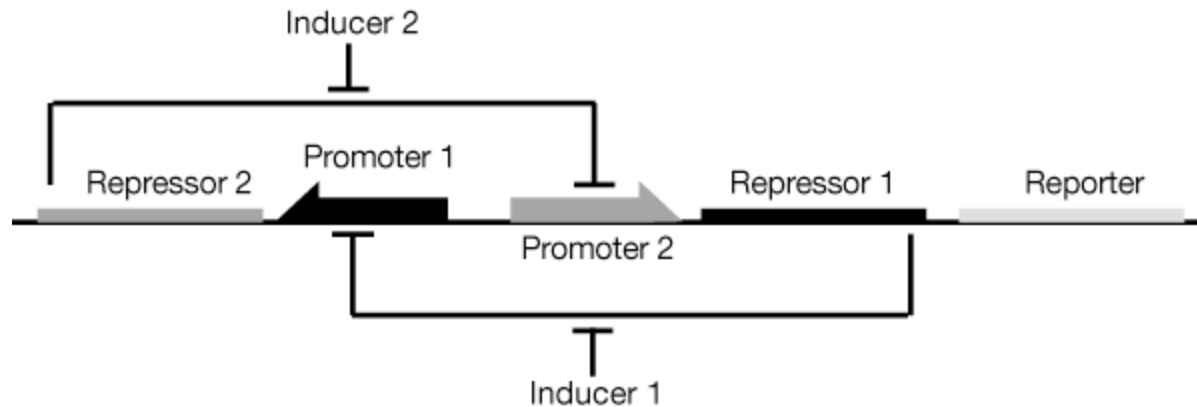

A Bi-stable Toggle Switch

Construction of a genetic toggle switch in *Escherichia coli*

Timothy S. Gardner^{*†}, Charles R. Cantor^{*} & James J. Collins^{*†}

^{*} Department of Biomedical Engineering, [†] Center for BioDynamics and [‡] Center for Advanced Biotechnology, Boston University, 44 Cummington Street, Boston, Massachusetts 02215, USA



A Tristable Toggle Switch

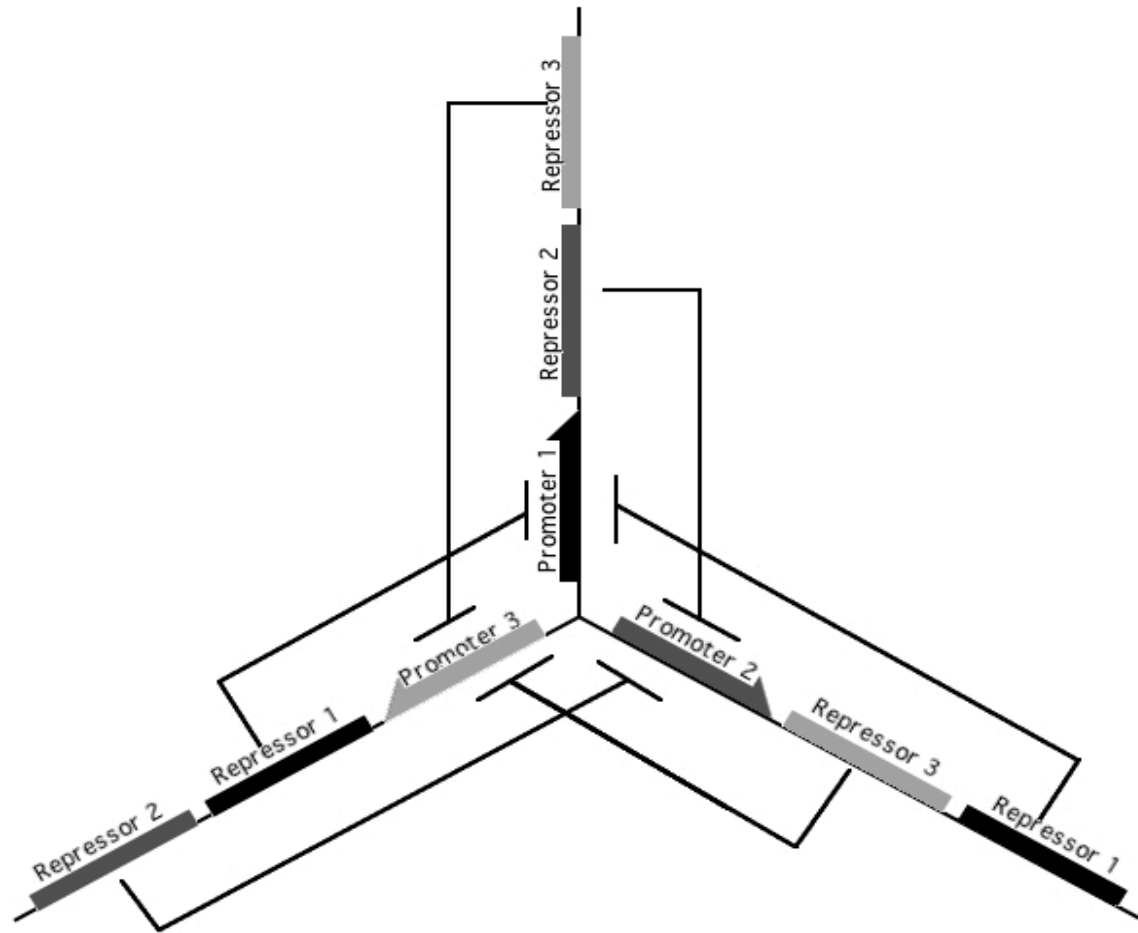

Let's watch in practice...

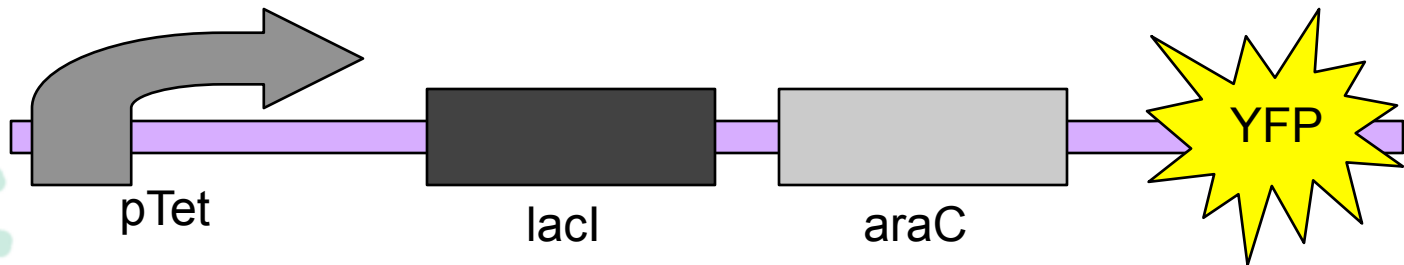
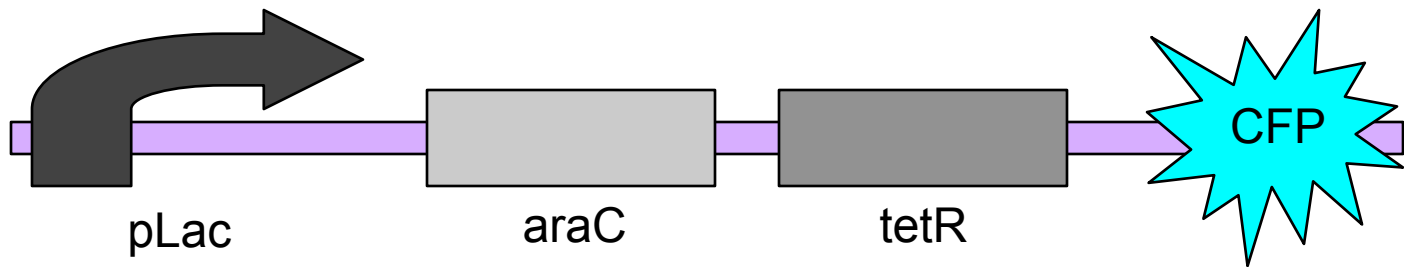
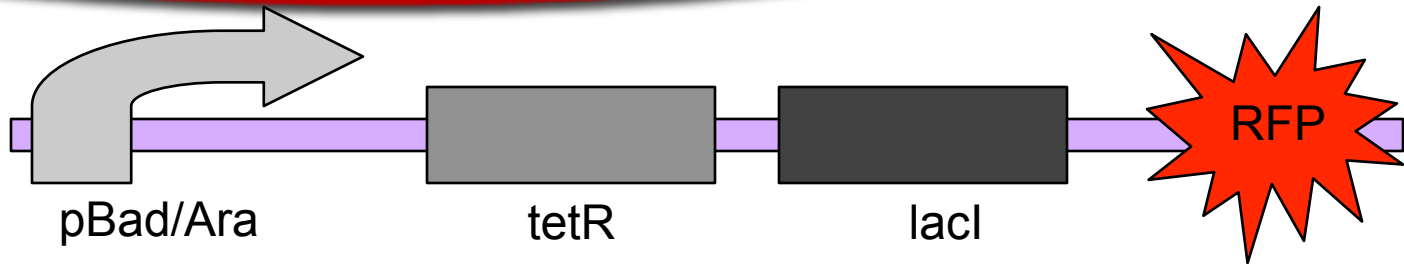

Let's watch in practice...

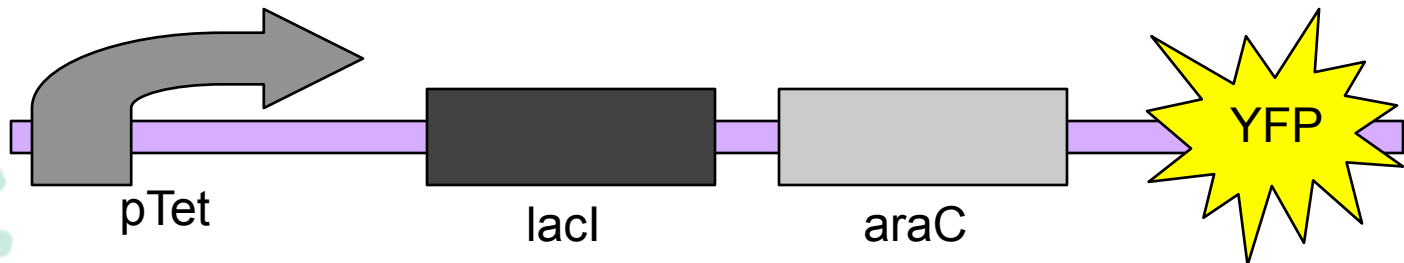
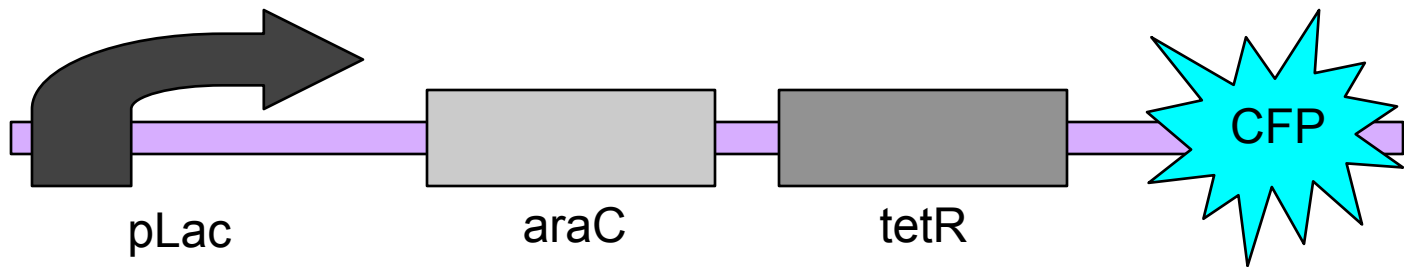
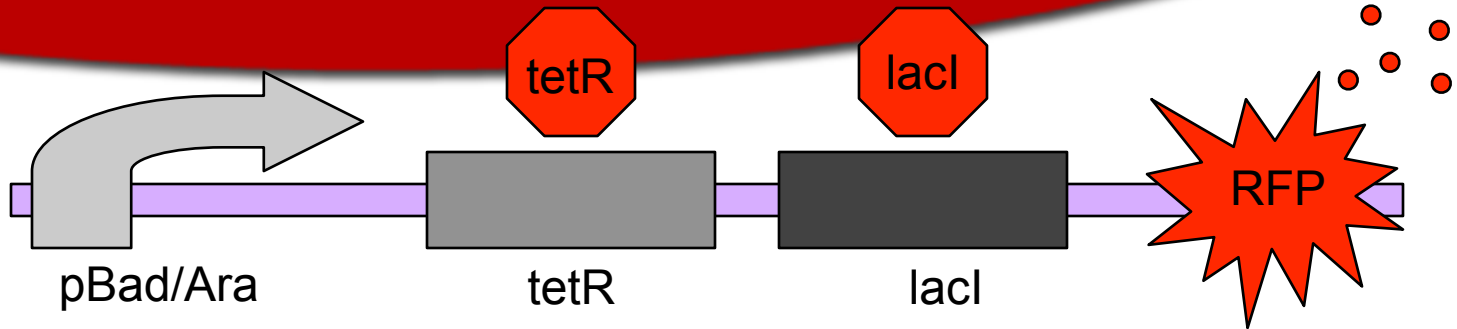

Let's watch in practice...

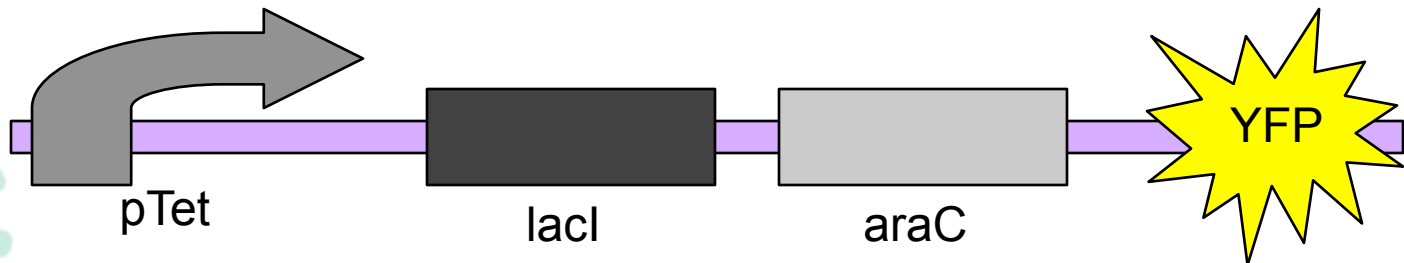
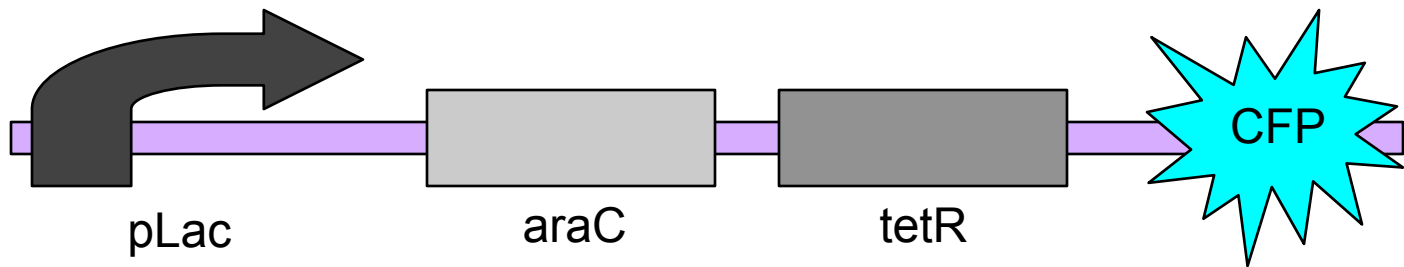
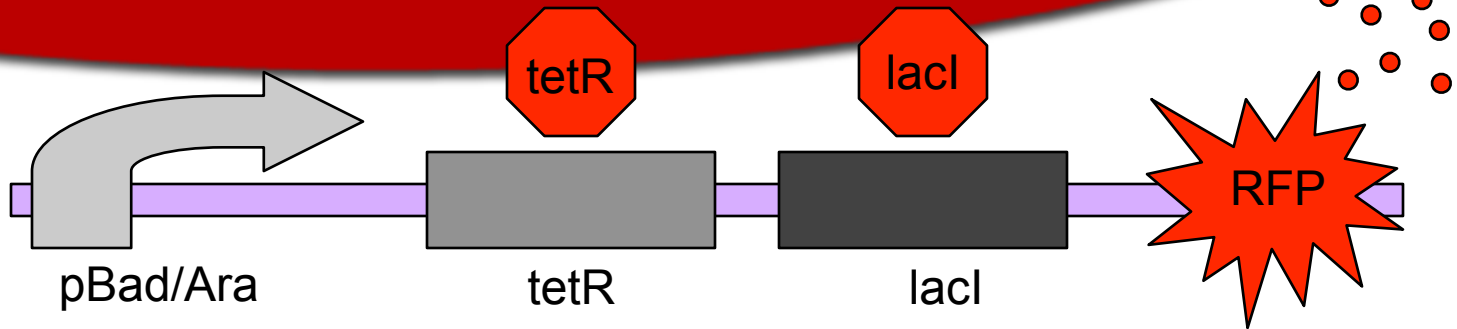

Let's watch in practice...

Without interruption, this state is stable.

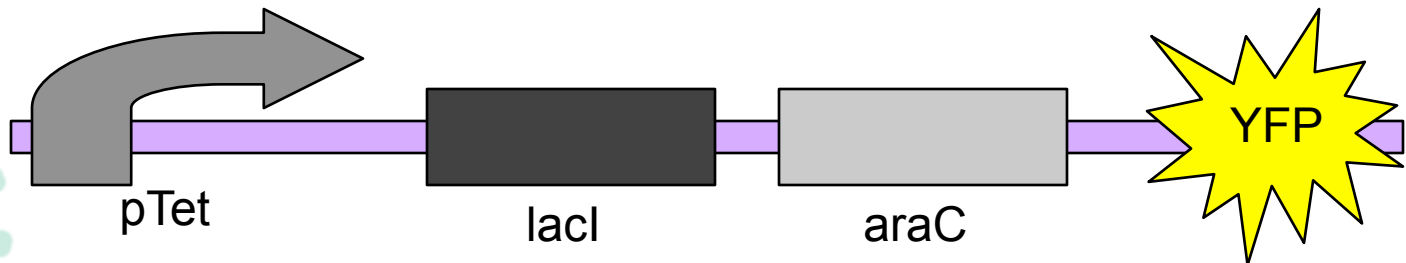
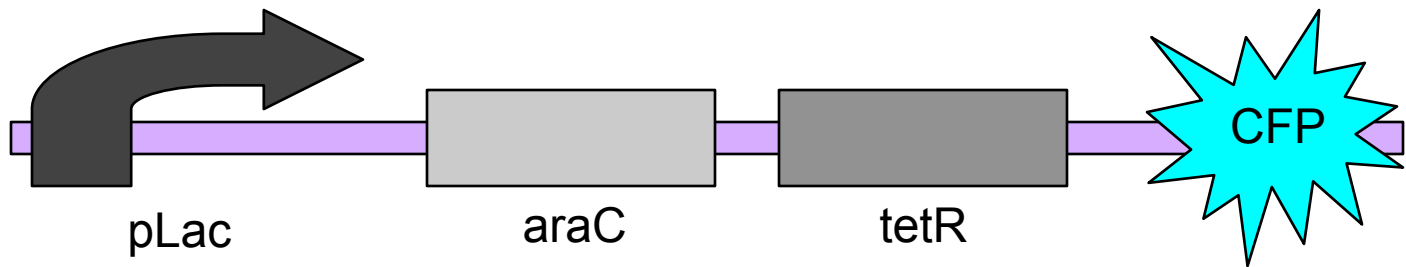
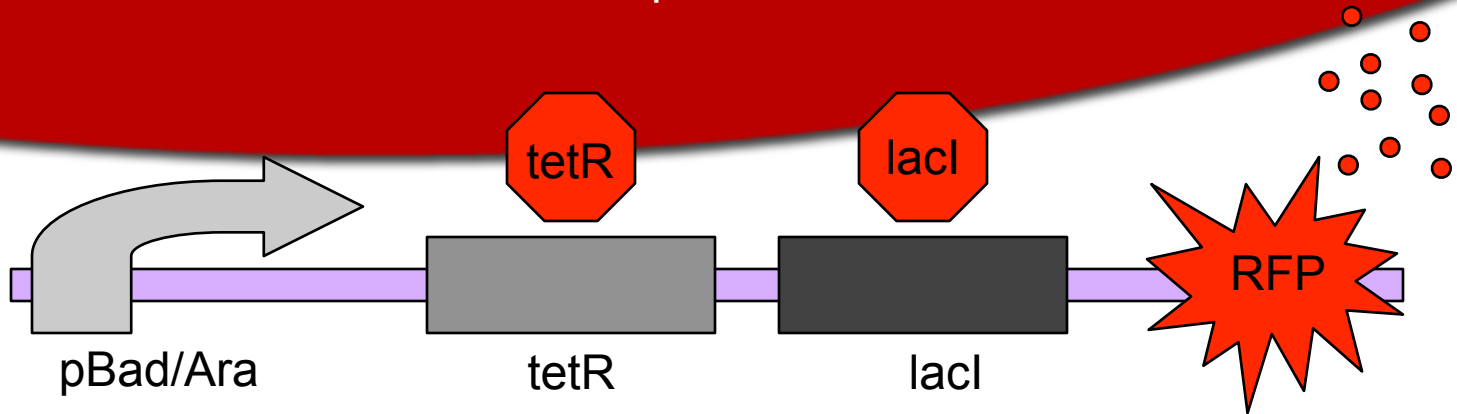

But we can induce a change with IPTG...

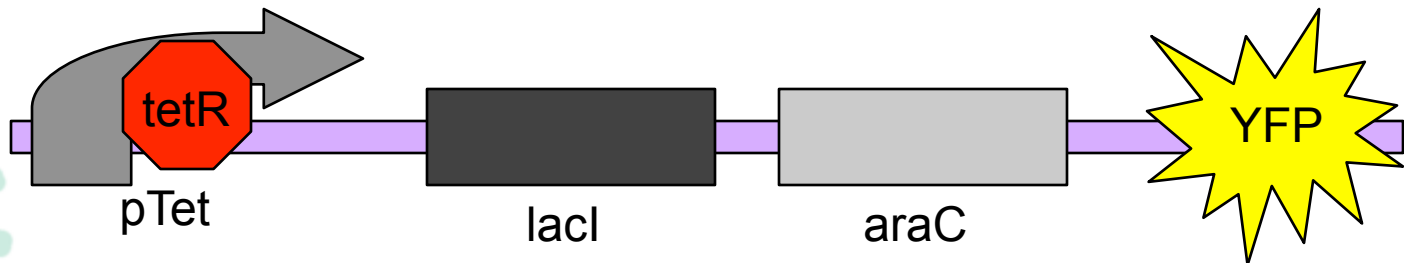
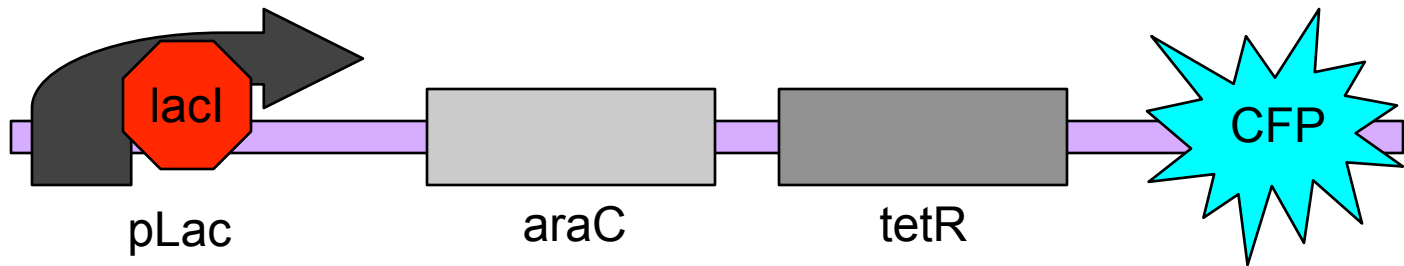
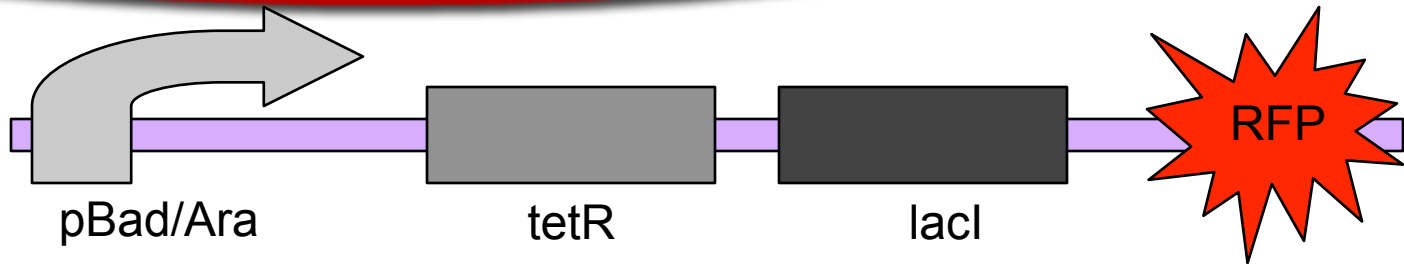

But we can induce a change with IPTG...

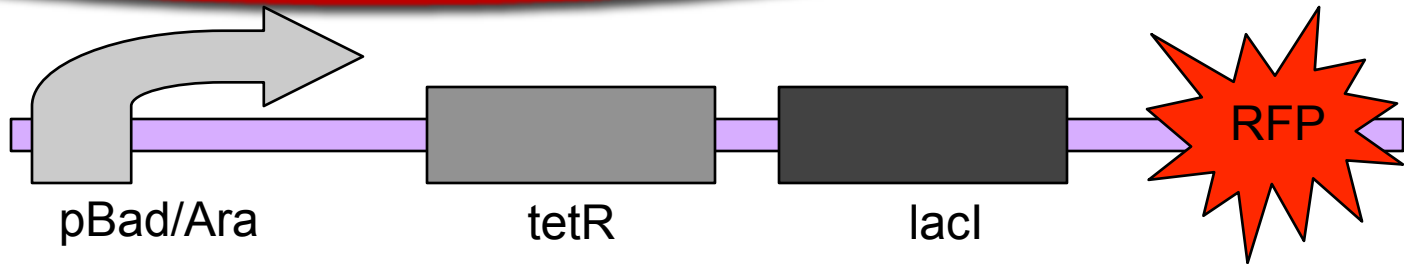

IPTG

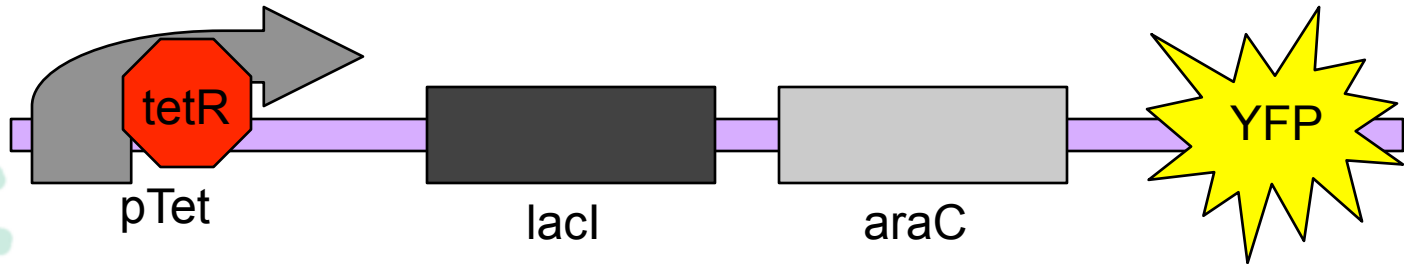
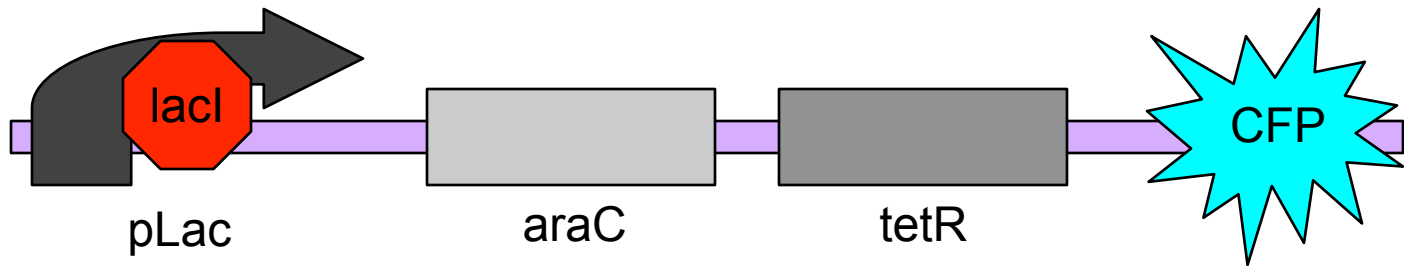

But we can induce a change with IPTG...

Without interruption, *this* state is stable.

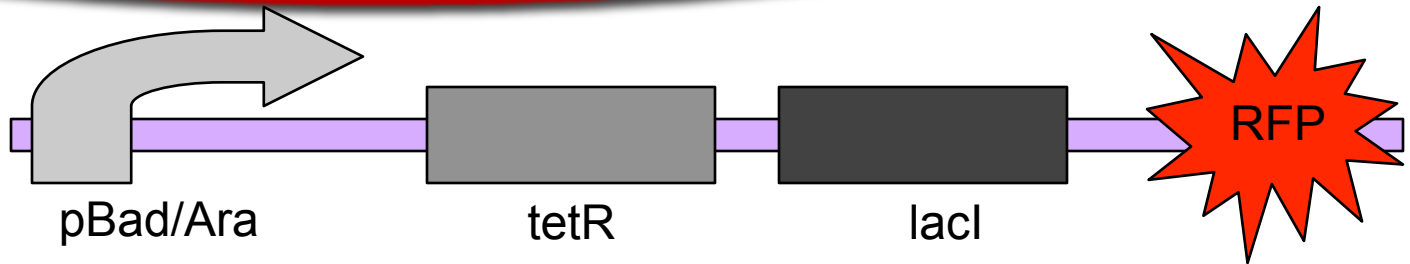

IPTG

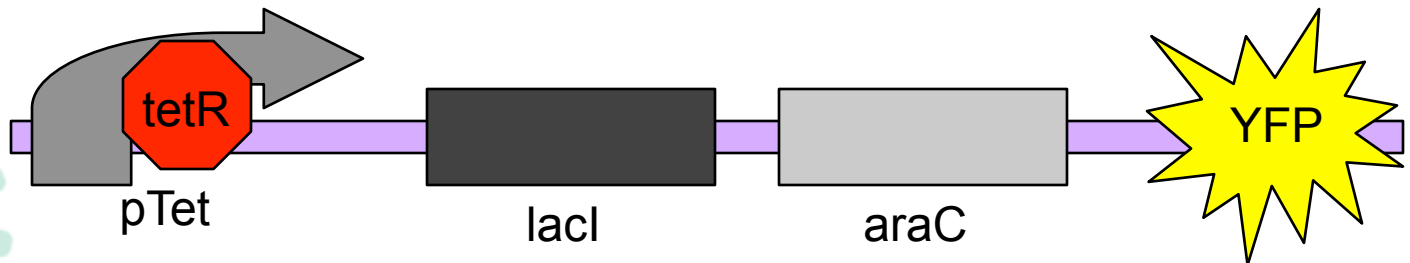
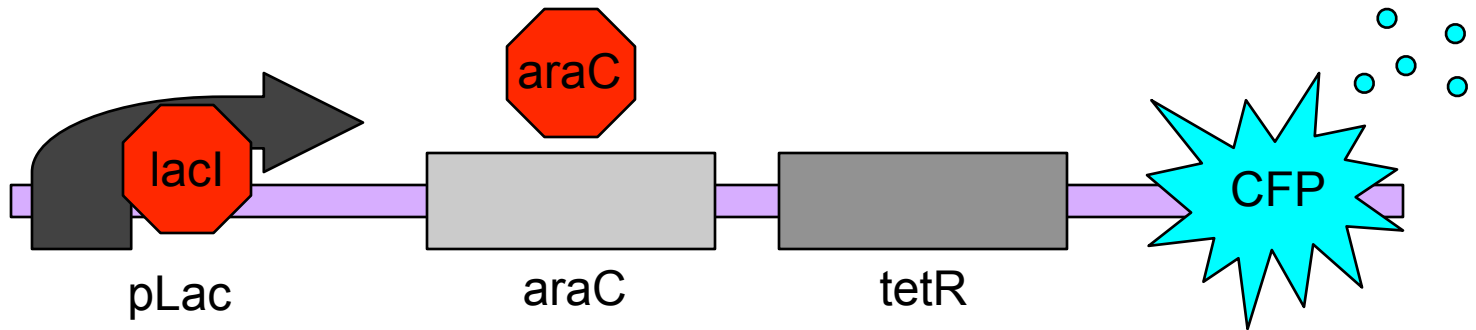

But we can induce a change with IPTG...

Without interruption, *this* state is stable.

We could have induced the pBad/Ara pathway with arabinose or the pTet pathway with tetracycline.

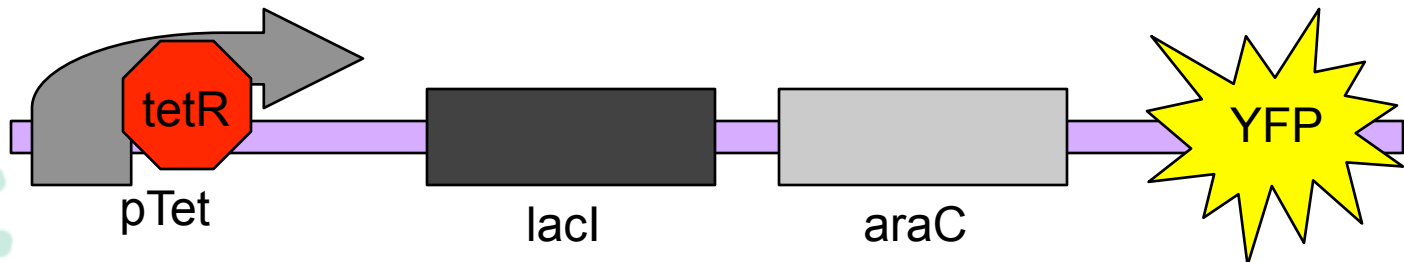
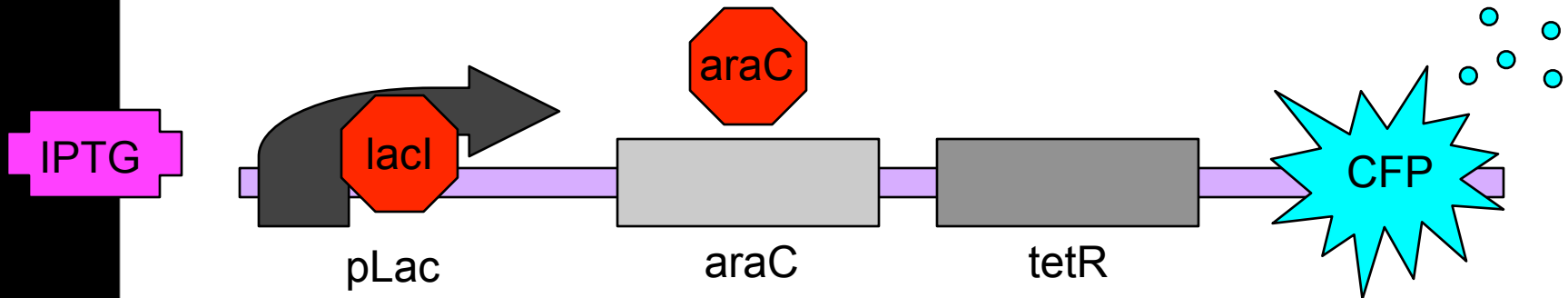
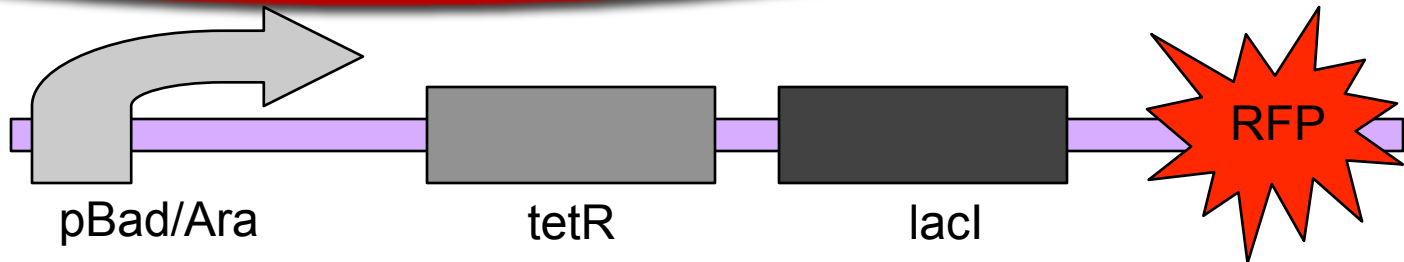

Modeling

Deterministic Model based on:

“Prediction and measurement of an autoregulatory genetic module.”

Isaacs et al. PNAS 2003

And

“A Bottom-Up Approach to Gene Regulation.”

Guido et al. Nature 2006



Model Derivation

Basic Idea

Fast reactions – “merizations” and operator binding events

- equilibrium equations

Slow reactions – transcription, translation, degradation

- differential equations

Combine these equations with an equation for total molecules in the system based on plasmid copy number

Manipulate these equations to derive an expression for the evolution of protein monomers/time



Model Derivation

Fast reactions – k's on order of seconds

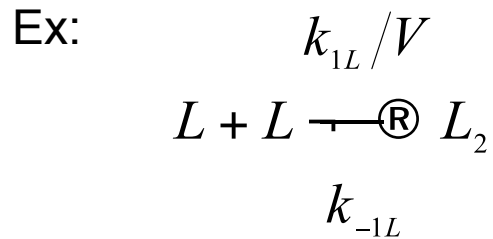

Dimer formation

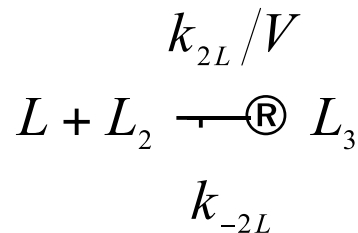

Trimer formation

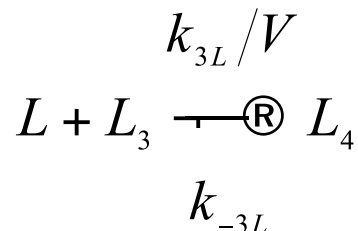

Tetramer formation

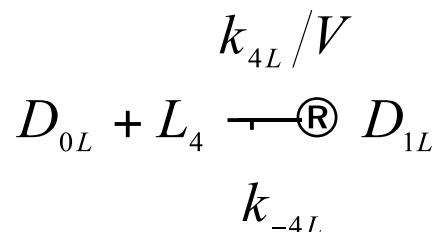

Operator binding

Equilibrium equations

Ex:

$$l_2 = \frac{k_{1L}}{k_{-1L}V} l^2$$

$$l_3 = \frac{k_{2L}}{k_{-2L}V} l_2 l$$

$$l_4 = \frac{k_{3L}}{k_{-3L}V} l_3$$

$$d_{1L} = \frac{k_{4L}}{k_{-4L}V} l_4 d_{0L}$$



Model Derivation

Slow reactions – k's on order of minutes

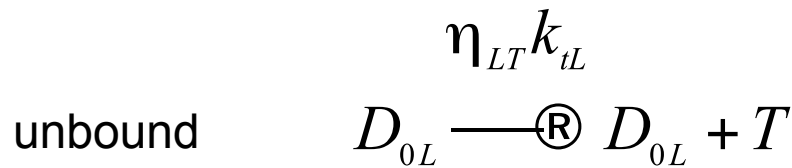

Transcription and translation of TetR from unbound and bound pLacI promoters

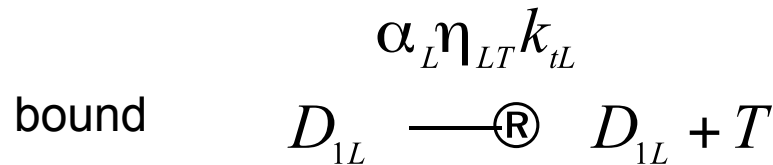

Differential equations

Ex:

$$\frac{dZ_T}{dt} = \eta_{AT} \beta_A (d_{0A} + d_{1A} + \alpha_{A1} d_{2A} + \alpha_{A2} d_{1aA} + \alpha_{A3} d_{2aA}) + \eta_{LT} \beta_L (d_{0L} + \alpha_L d_{1L}) - \gamma_T T$$



Model Derivation

Slow reactions – k's on order of minutes

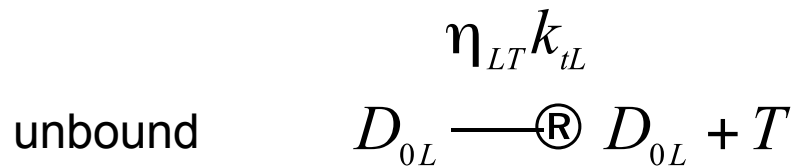

Transcription and translation of TetR from unbound and bound pLacI promoters

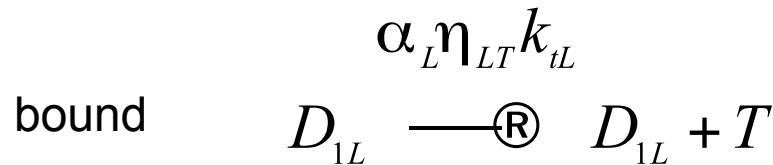

Differential equations

Ex:

$$\frac{dZ_T}{dt} = \eta_{AT} \beta_A (d_{0A} + d_{1A} + \alpha_{A1} d_{2A} + \alpha_{A2} d_{1aA} + \alpha_{A3} d_{2aA}) + \eta_{LT} \beta_L (d_{0L} + \alpha_L d_{1L}) - \gamma_T T$$

TetR created by pBAD promoter



Model Derivation

Slow reactions – k's on order of minutes

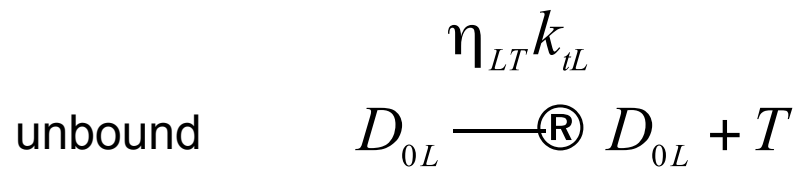

Transcription and translation of TetR from unbound and bound pLacI promoters

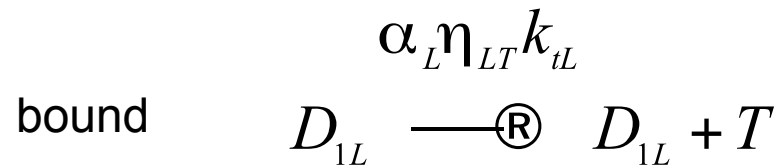

Differential equations

Ex:

$$\frac{dZ_T}{dt} = \eta_{AT} \beta_A (d_{0A} + d_{1A} + \alpha_{A1} d_{2A} + \alpha_{A2} d_{1aA} + \alpha_{A3} d_{2aA}) + \eta_{LT} \beta_L (d_{0L} + \alpha_L d_{1L}) - \gamma_T T$$

TetR created by pLacI promoter



Prediction – no inducer

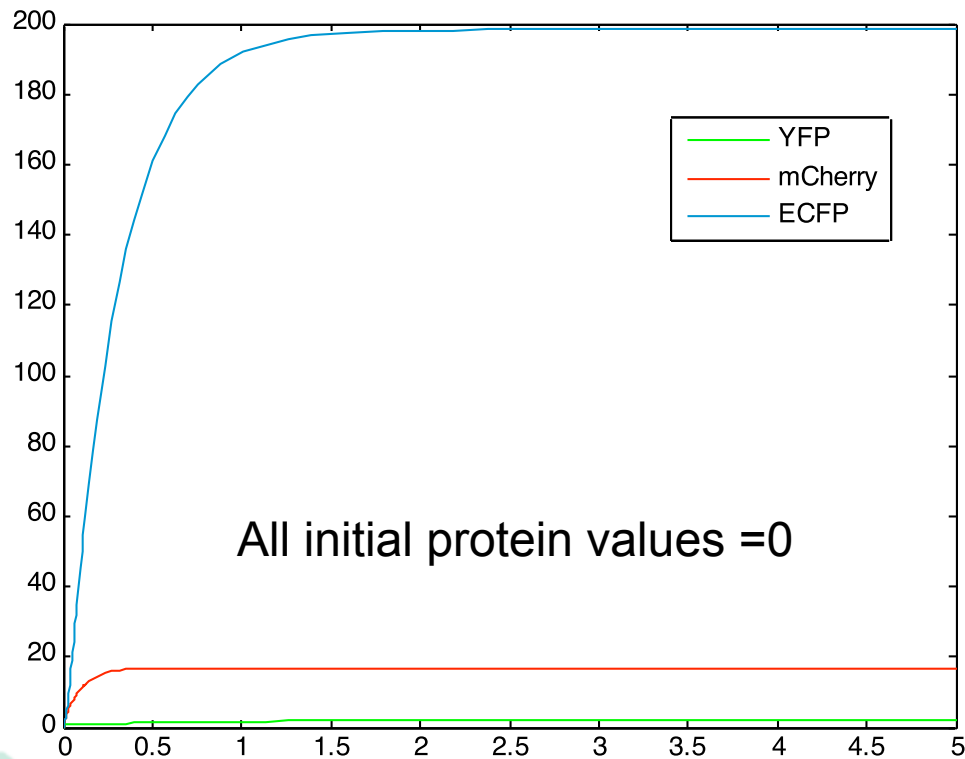

KEY:

pBAD è mCherry

pLacI è ECFP

pTetR è YFP

System Reaches a natural steady state - pLacI promoter dominates!



Prediction - Tetracycline

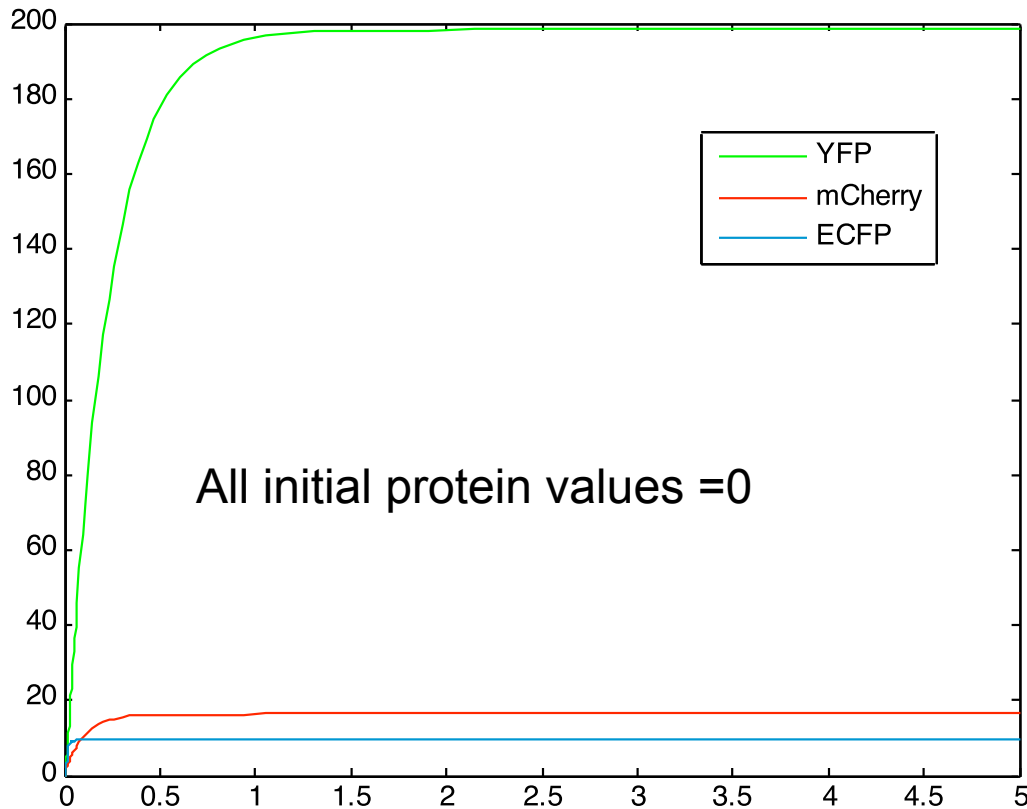

KEY:

pBAD è mCherry

pLacI è ECFP

pTetR è YFP



Model CONFIRMS our hypothesis in the presence of tetracycline!

Test for stability

Will the tri-stable switch work...?

- Plug in final protein concentrations from induced state into inducer-less system
- Test whether state remains stable



Test for stability

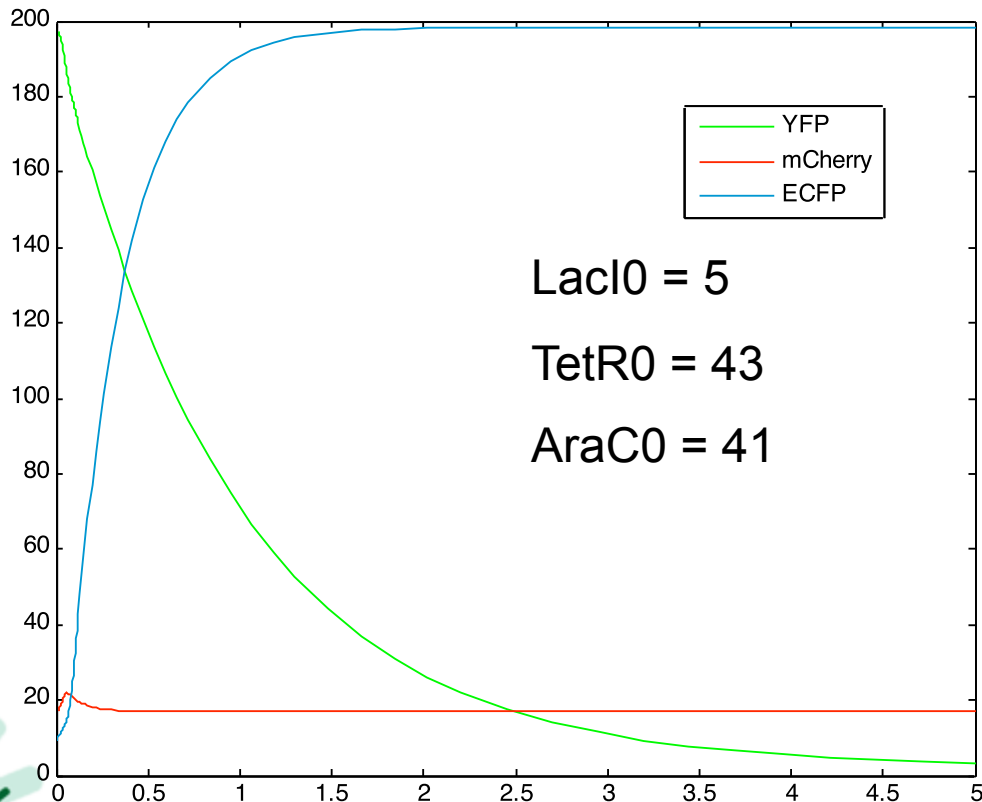

KEY:

pBAD è mCherry

pLacI è ECFP

pTetR è YFP



System switches back to natural steady state!

pTetR stability test

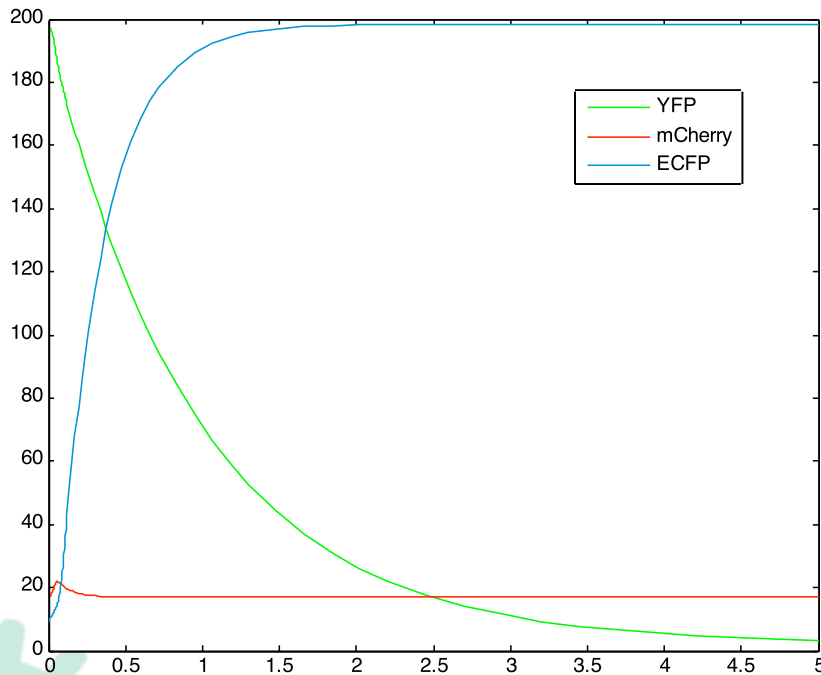

Natural steady state

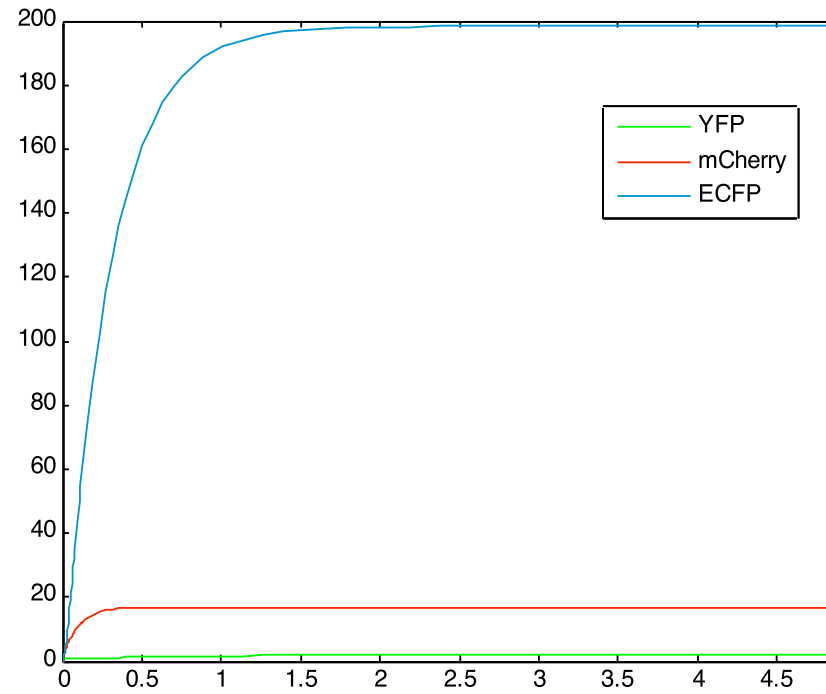

Future

- Experimentally obtain more appropriate model parameters
- Run parameter scans for tri-stability
 - Potentially identify proper regulatory elements and or tinkering required to for tri-stability
- Add stochastic variation to the model



Conclusions

- Tri-stable Toggle Switch
 - Our model predicts that a tri-stable switch given our experimental setup will be unable to reach a stable state following transient induction
- Freeze-tag
 - Theoretically shows an interesting biological circuit which uses cell-cell communication with a bi-stable circuit to create a novel observable interaction
 - Circuit complexity may jeopardize the efficiency of the system by causing a build-up of various proteins. Modifications of the circuit may be required to circumvent such effects.



Special thanks to:

- Gary Wessel
- Tayhas Palmore
- Alex Brodskey
- Nicola Neretti
- Karen Haberstroh
- David Targan
- Ruth Simmons
- Houseknecht lab @ Pfizer
- Sir Josiah Carberry

