

ETH

Eidgenössische Technische Hochschule Zürich
Swiss Federal Institute of Technology Zurich

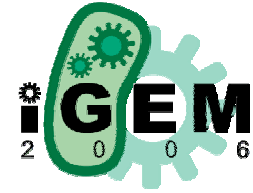

Half Adder - Modeling Overview

September 4th, 2006



System Architecture

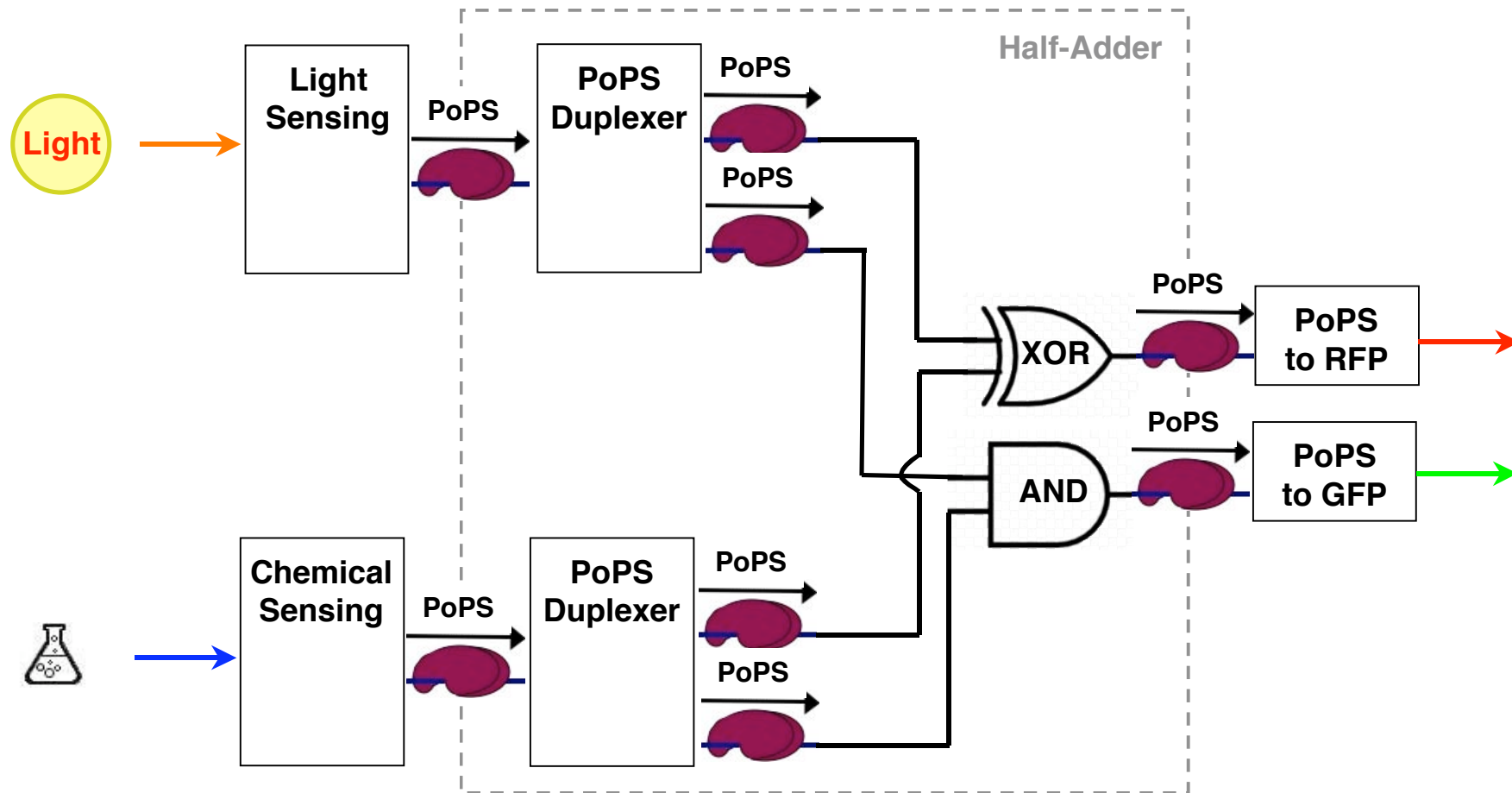

Insights Overview

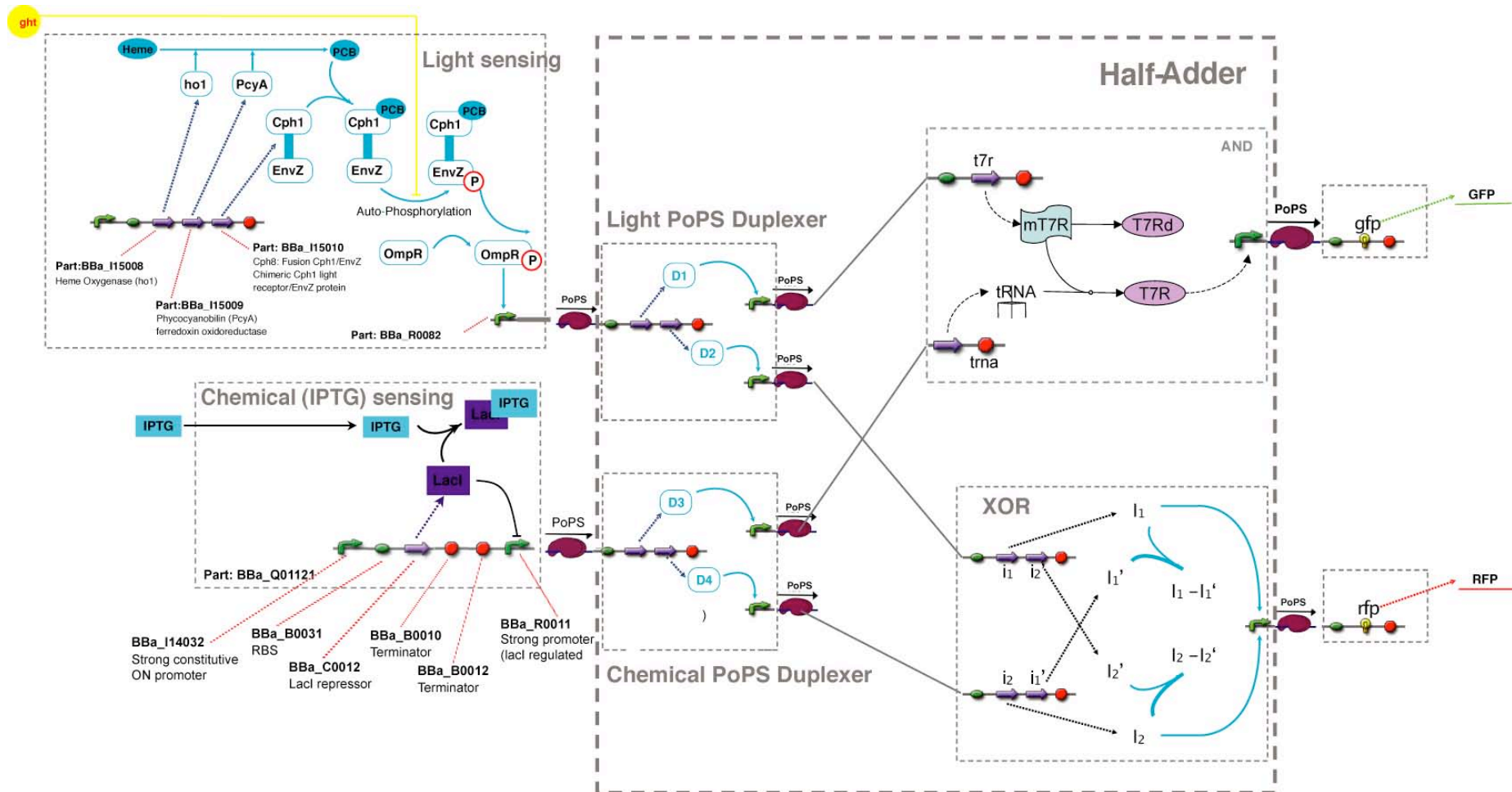

Light Sensing

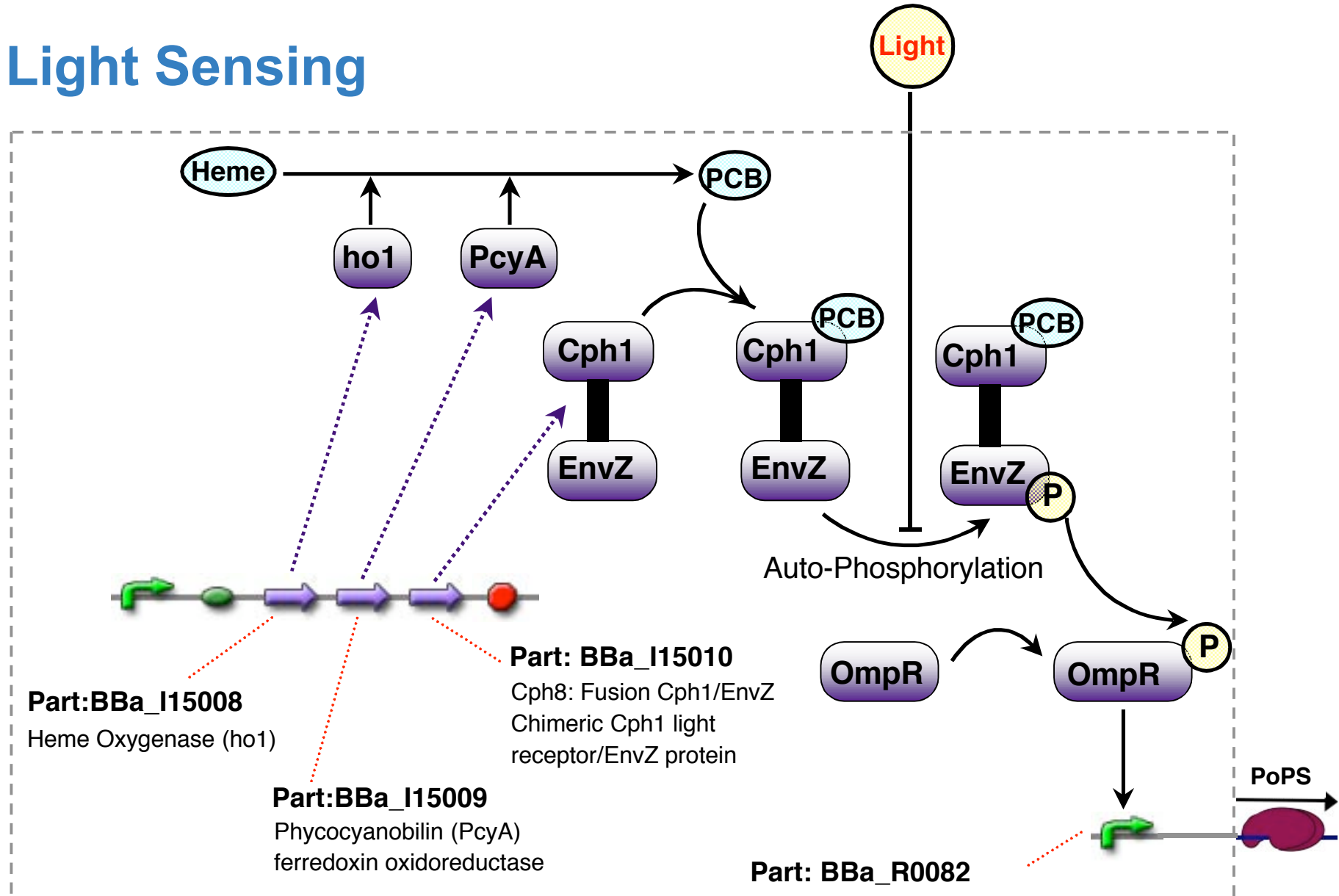

Chemical Sensing

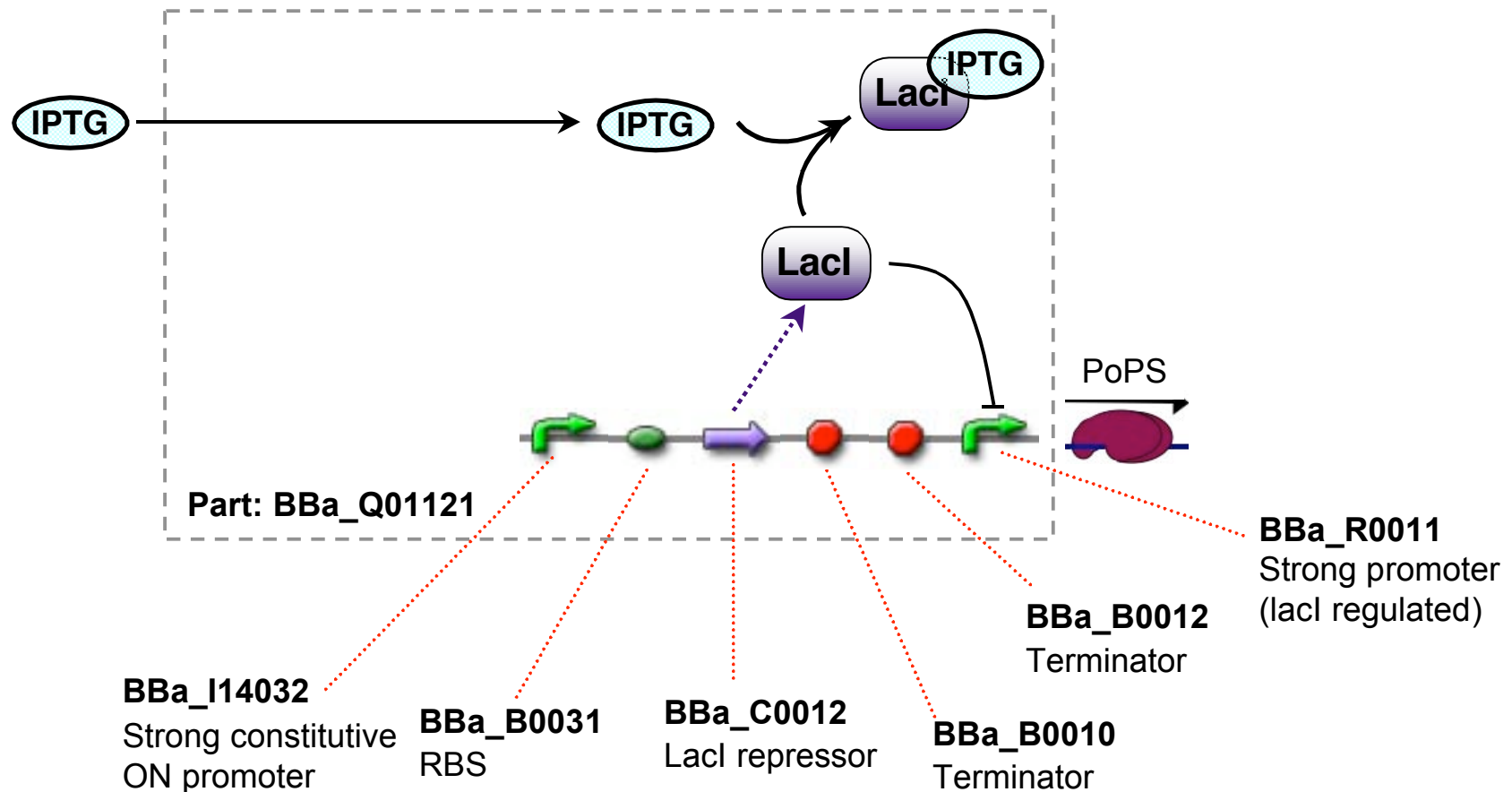

PoPS Duplexer

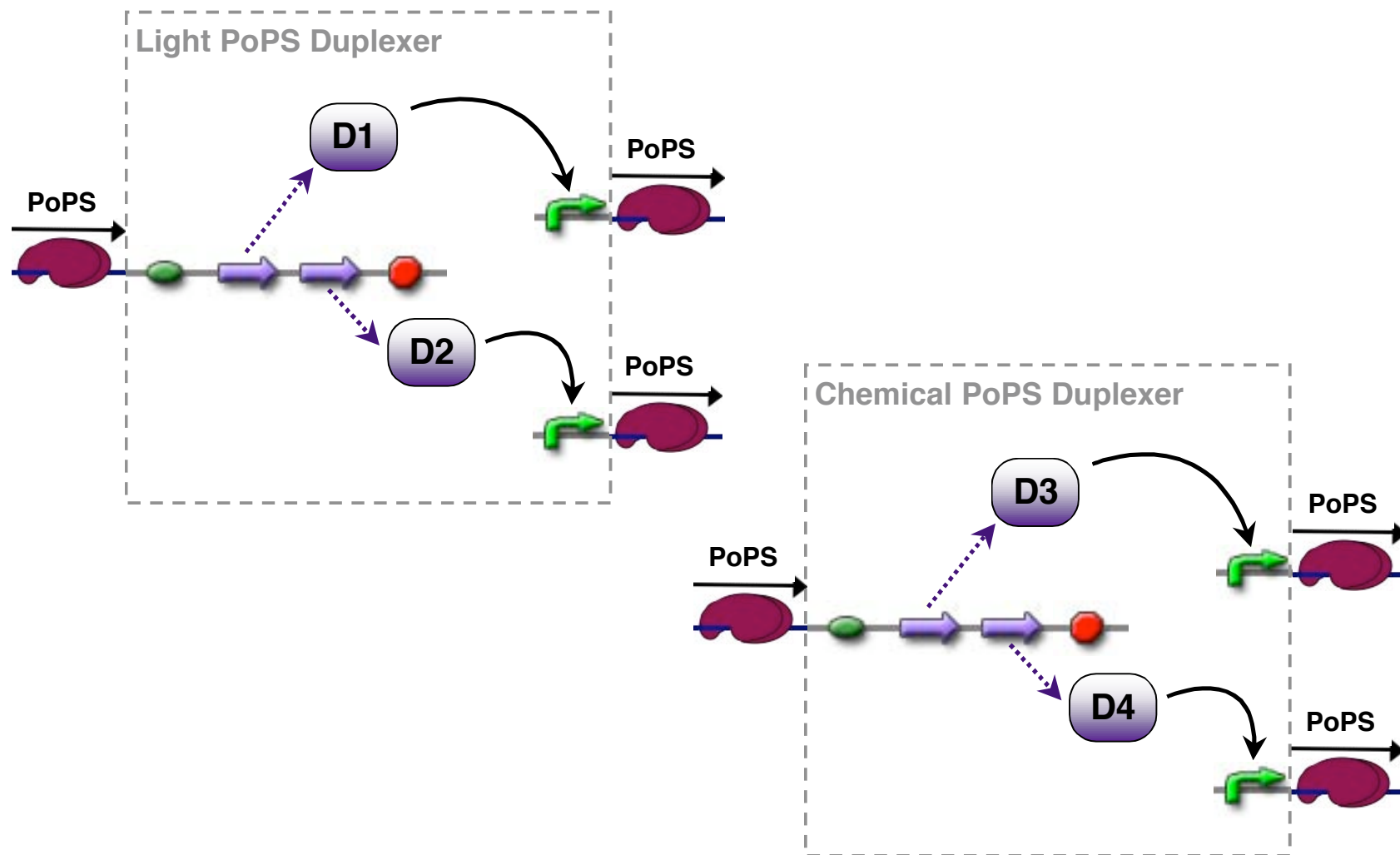

PoPS Duplexer Simplified

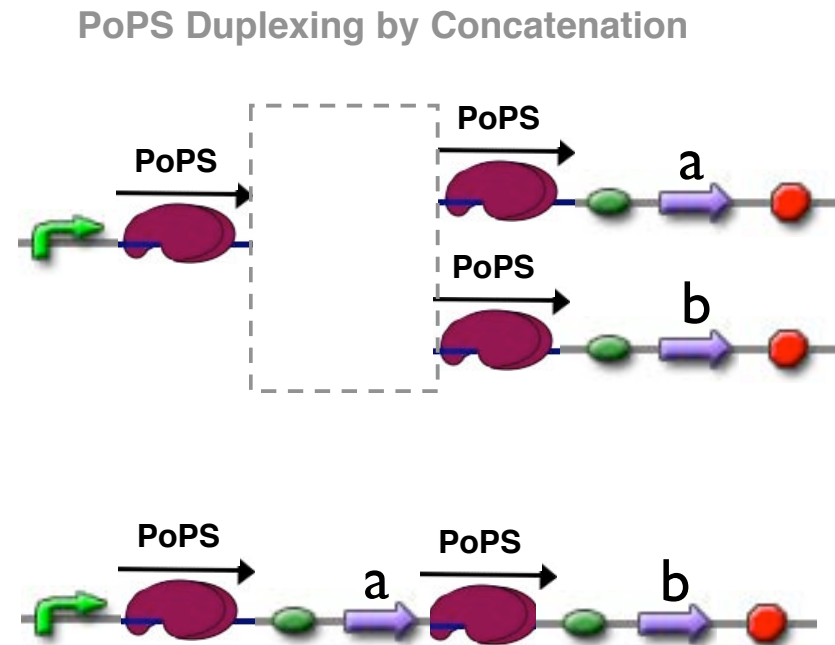
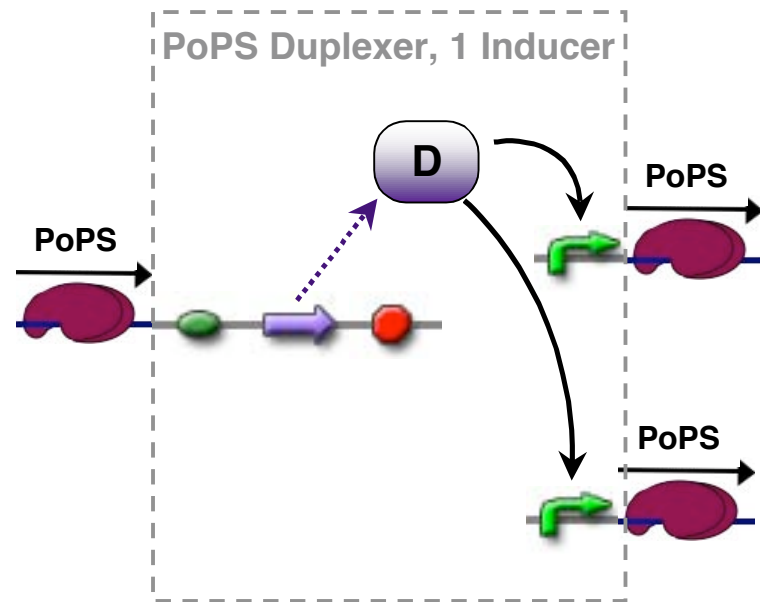

AND (tRNA)

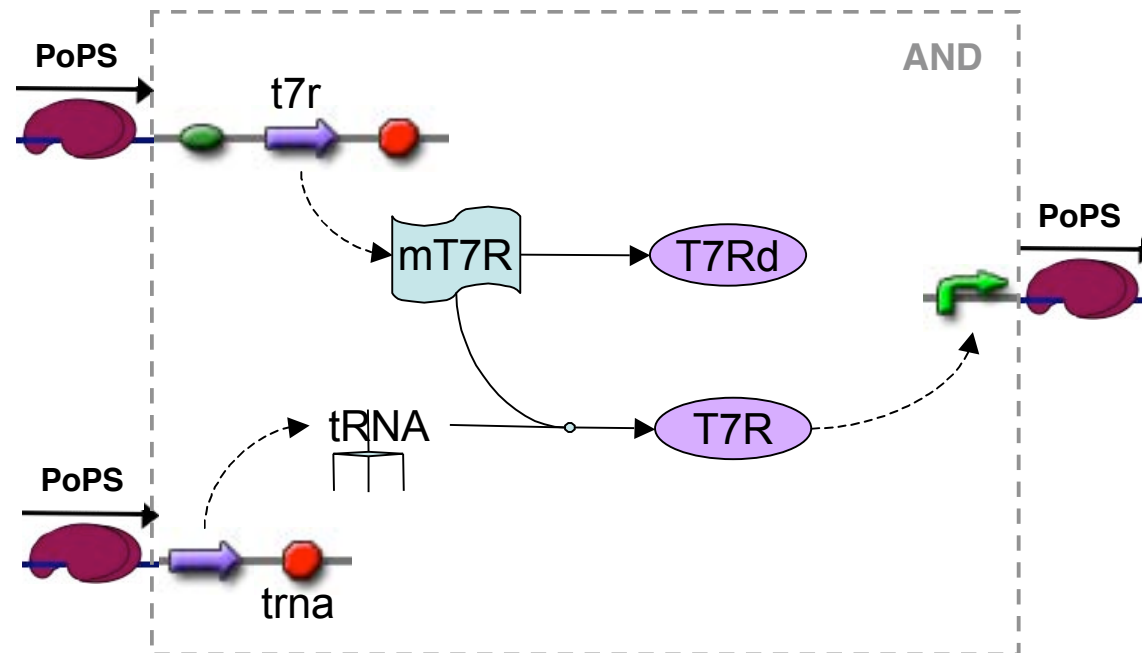

T7R: T7 RNA Polymerase
 T7Rd: deficient (inactive) T7R
 mT7R: mRNA for T7R
 tRNA: tRNA to repress „early stop“ translation

XOR

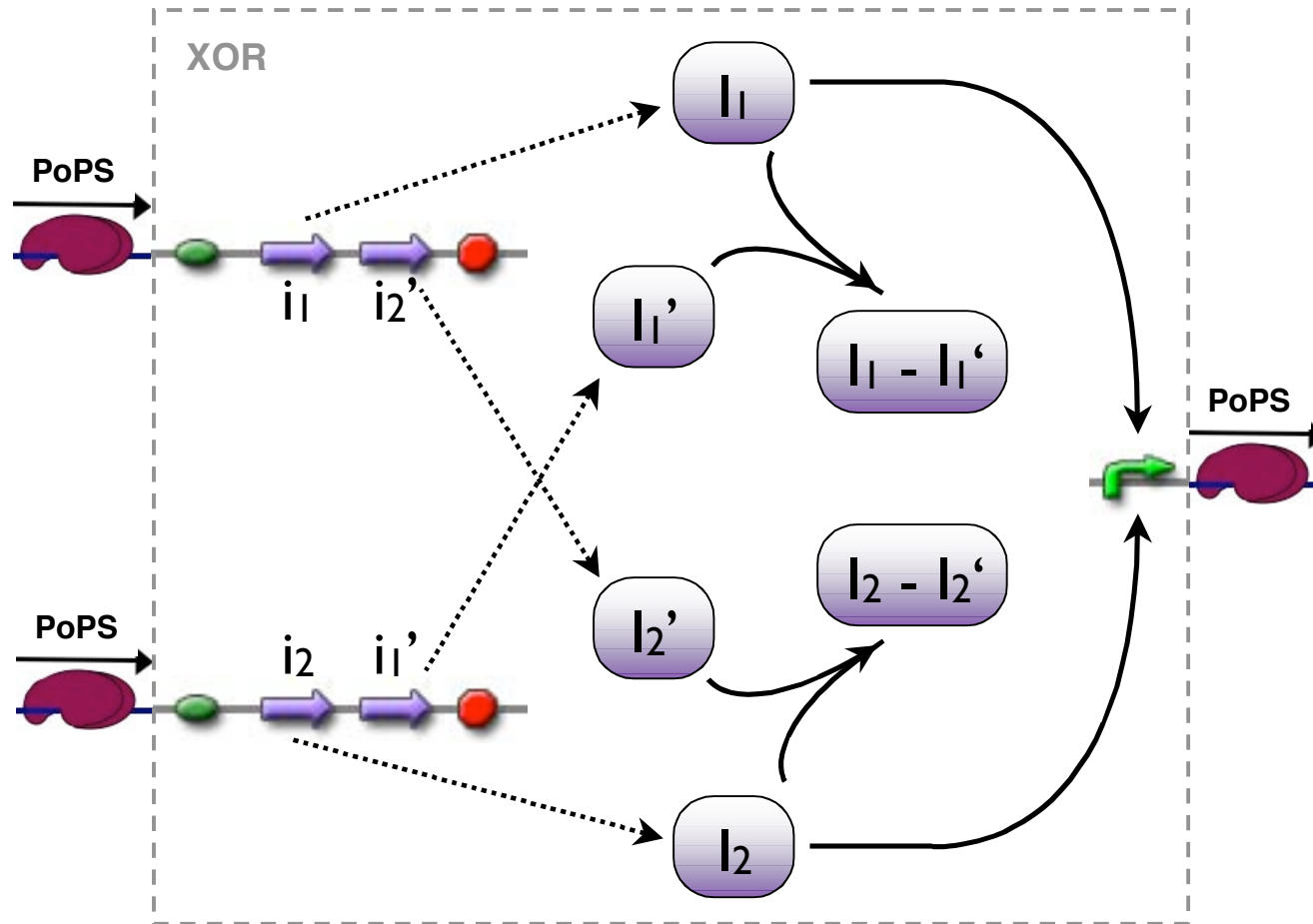

PoPS to Reporter

